

Industrial Peristaltic Pumps

AMP-10B Data sheet

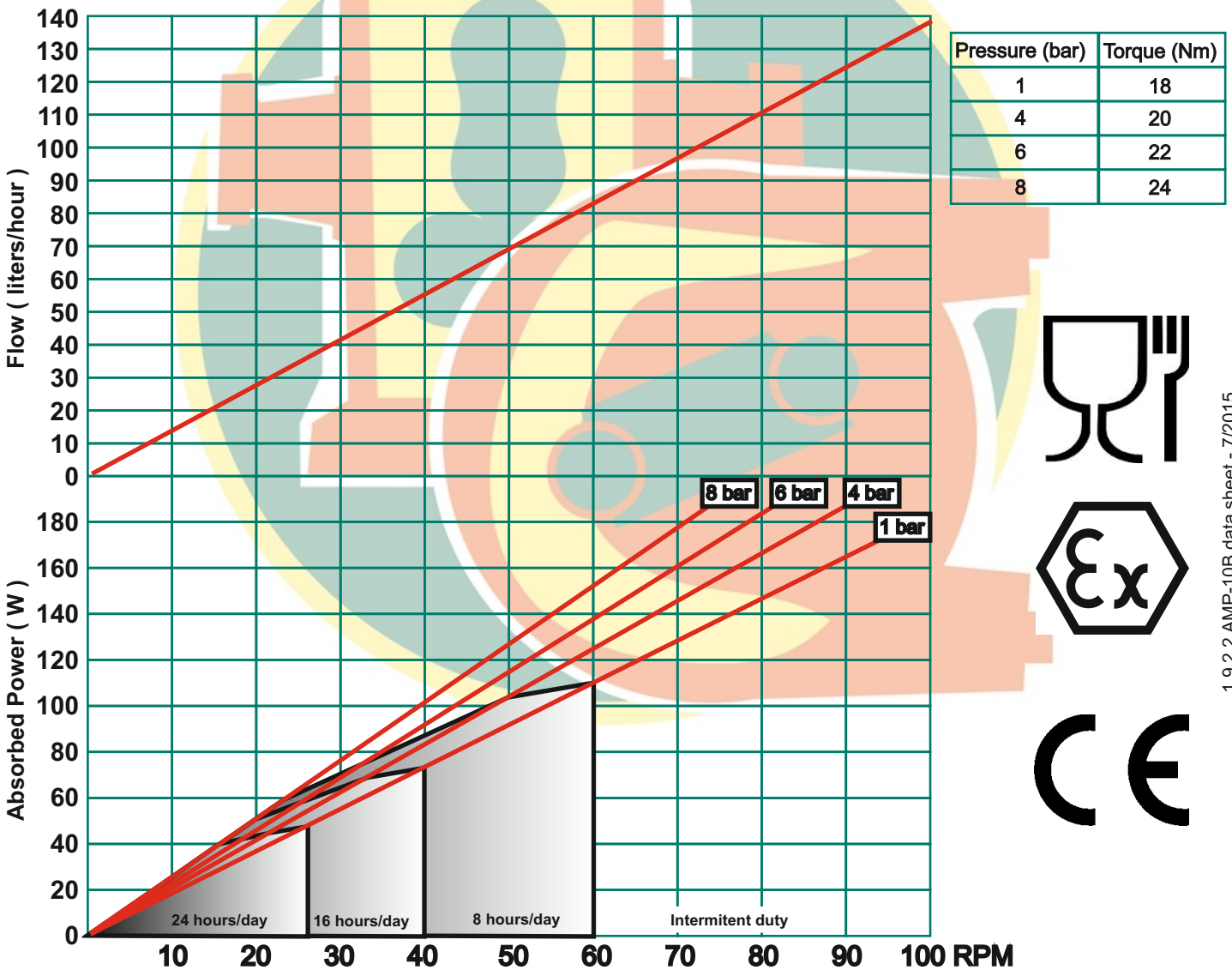

Capacity: 0,023 l/rev.
Connections: 3/8"
Max. Pressure: 8 bar
Rotor system: Rollers
Available hoses: NR
 NBR
 EPDM
 HYPALON
 NR-A
 NBR-A
Available tubes: Norprene



Description	Material	Surface treatment
Pump housing	Alluminium EN-AC-44100	Polyester powder coated Halar coated (Optional)
Front cover	Methacrylate	--
Rotor	Nodular Cast Iron EN-GJL-400	Cataforesis
Rollers	Steel F-114	Blueing
Base plate	Steel F-111 Stainless Steel AISI-304 (Optional)	Polyester powder coated --
Connections	Stainless Steel AISI-316 Polypropylene (Optional) PVDF (Optional)	--

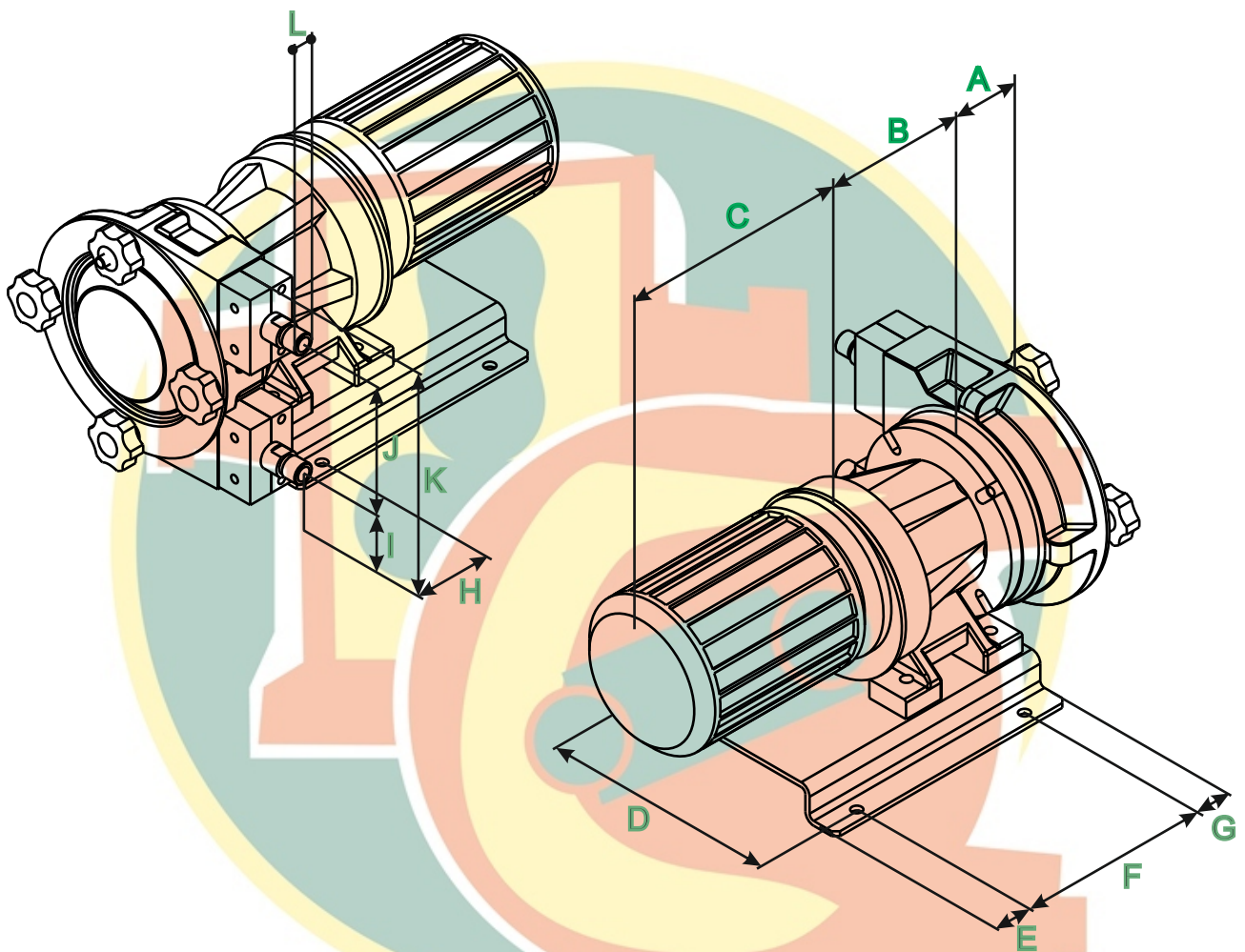

A	B	C	D	E	F	G	H	I	J	K	L
70	*	*	190	30	160	30	61	60	115	210	3/8" BSP

