

VERTICAL CENTRIFUGAL PUMPS

IM 155

MADE IN ITALY 

- **Product of Italian origin**
- Available in PP-PVDF
- Pump immersed in tank
- Removable motor even with pump installed
- No welded seams
- Operation also possible with heavily soiled fluids, with solids in suspension
- Max. flow rate 42 m³/h
- Max head 27 m
- Open impeller Ø 162 mm x H 4 mm (Standard impeller, for any special design with reference to the pumped fluid contact DEBEM's technical support), 10 gradi
- Simple replacement of wear bushing
- Extremely easy maintenance
- Also available without motor
- Low cost of spare parts
- Viscosity up to 500 CPS
- Column length: 500 / 800 / 1000 / 1250 mm (*other sizes on request*)
- Operating temperatures:
PP min. +3°C / max. +65°C
PVDF min. +3°C / max +95°C
- Continuous operation: YES
- Warranty: 1 year, according to our general conditions of sale
- Spare parts: to identify the spare parts check the exploded views provided at the end of the operation and maintenance manual.

MODEL	Kw MOTOR	HP	MOTOR SIZE	RPM	MOTOR SPECIFICATIONS
IM155	5,5	7,5	B5	2900	THREE-PHASE 400/690 V-50/60 HZ 2-POLE efficiency class IE2 protection rating IP55 - Ambient temperature -30°C + 45° C / ATEX motor available

ATTENTION: technical data for standard motor, for any special design with reference to the pumped fluid contact DEBEM's technical support.



Intake connections G 2" 1/2 f (or DN 65 on request)
Delivery connections G 2" m (or DN 50 on request)
Max. flow rate 42 m³/h
Max. head 27 m
Construction materials PP - PVDF

CE

DEBEM
MADE IN ITALY

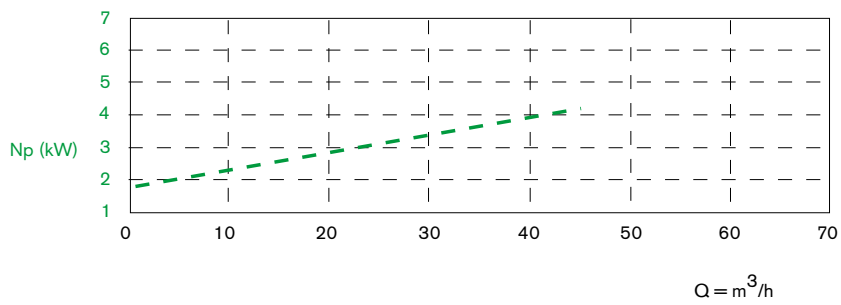
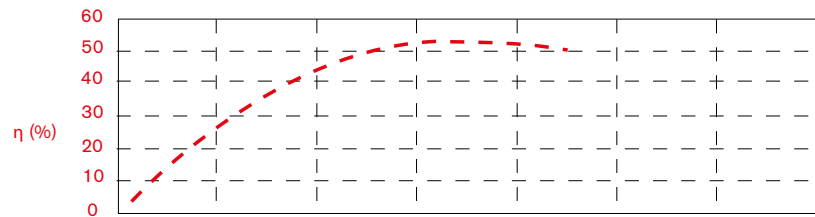
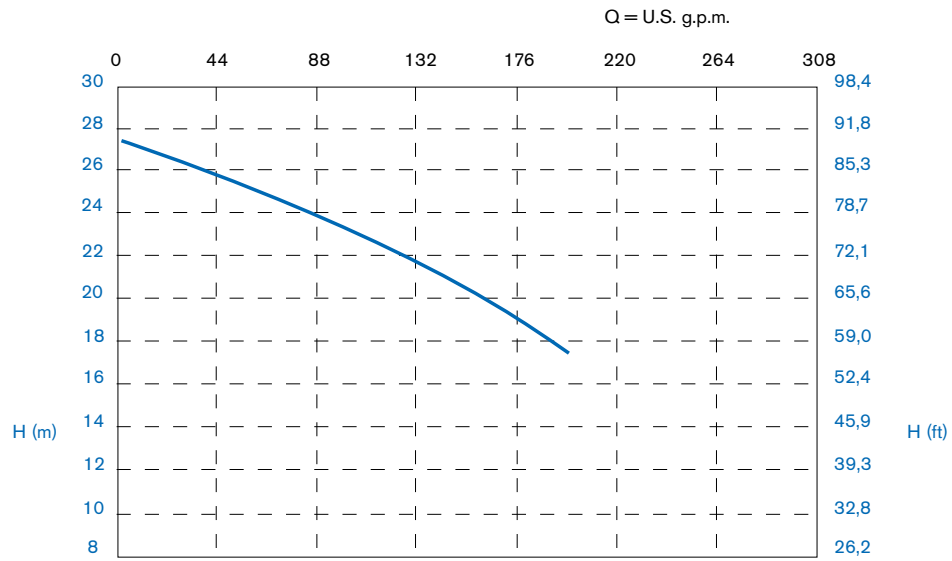

The curves and performance values refer to pumps spare delivery outlet and water at 20°C, 2 pole motor 50 Hz (2900rpm).

AVAILABLE MATERIALS

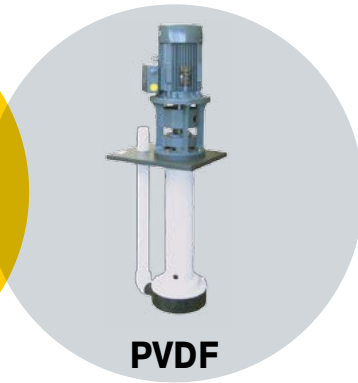
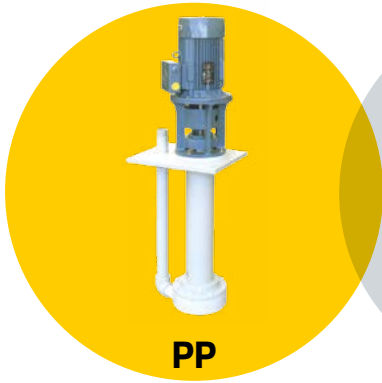

INSTALLATION

IN TANK

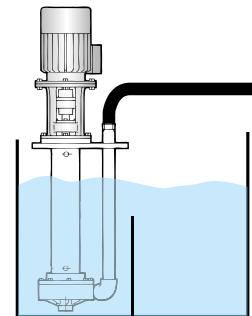

L column	Peso PP	Peso PVDF	L1 max.
500	28 Kg	30 Kg	300
800	31 Kg	33 Kg	600
1000	33 Kg	35 Kg	800
1250	36 Kg	38 Kg	1050

(Dimensions in mm - Other sizes available on request)

IM155 PP/PVDF

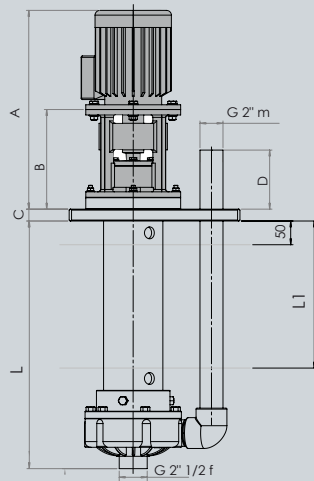

(Dimensions in mm)

IM155 PP/PVDF

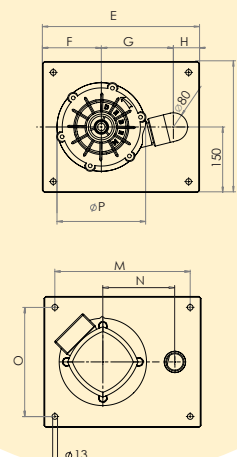

Packaging: wooden cage, for Pesos and dimensions contact Debem staff.

MODEL	POWER	Ø PASSING SOLIDS	A	B	C	D	E	F	G	H	I	M	N	O	P	KG MOTOR
IM 155	5.5 Kw - 7.5 HP	2	682	303	25	130	480	170	215	95	380	430	215	330	Ø275	53

IM COMPOSITION CODE

ex. **IM155P-V-0800-N**

IM155 in PP, O-Ring Viton, column length 800 mm, three-phase motor

IM155	P -	V	0800	N
PUMP MODEL	PUMP MATERIAL	O-RING	COLUMN LENGTH	MOTOR
IM155 - IM 155	P - Polypropylene FC - PVDF+CF	D - EPDM V - Viton	0500 - 500 mm 0800 - 800 mm 1000 - 1000 mm 1250 - 1250 mm	N* - Three-phase motor M - Single-phase motor A - ATEX motor

*Standard motor is the three-phase induction type with European voltage (2-pole) 50Hz

PRODUCT APPLICATION

