

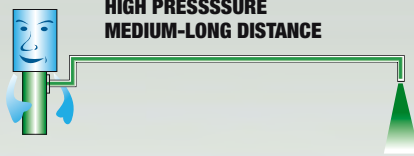

Air-operated pumps for DISTRIBUTION grease

Ratio 45:1
Flow rate 4400 g/min



Series 900 industrial air-operated pumps for short-long distance grease distribution, for high pressure greasing. Ideal for transferring grease and high viscosity oil. The double action guarantees the delivery of a continuous and constant flow, suitable for the numerous needs of modern industry. The high quality of the materials used and the anticorrosion treatments reduce internal friction and limit wear over time.

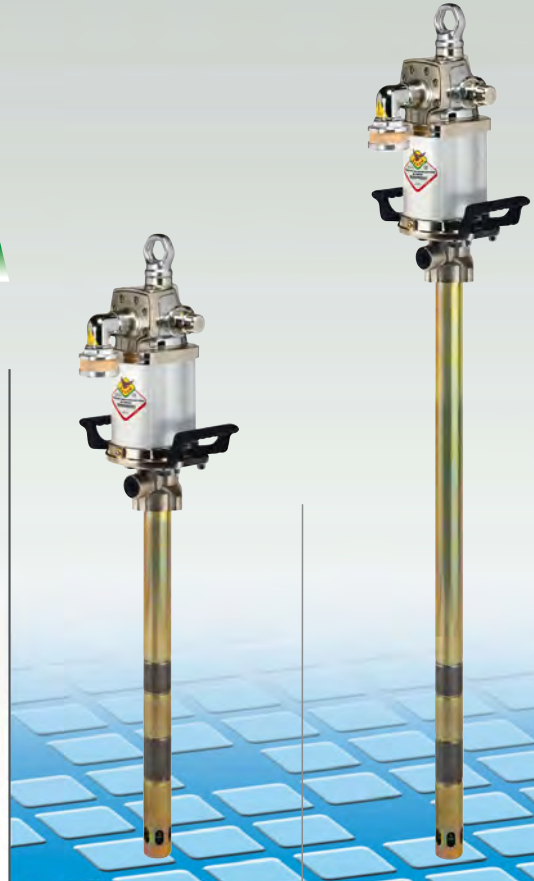
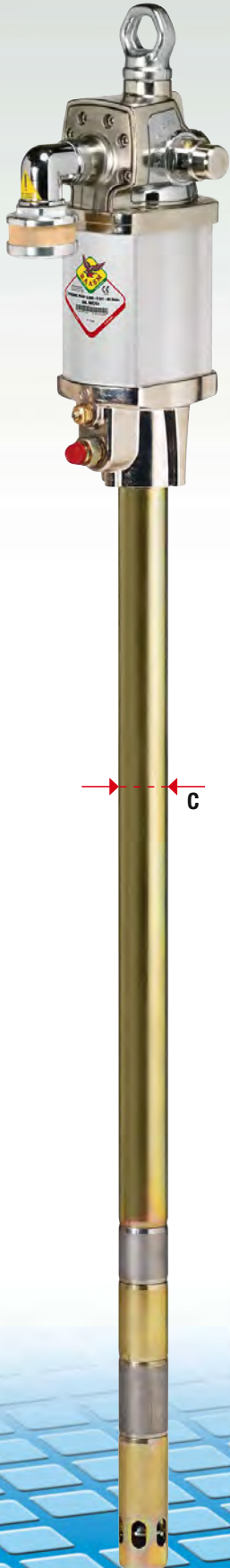

series 900

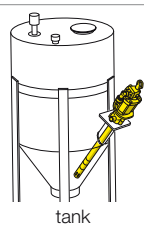
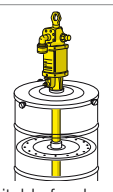
Article with seals in	PU	90F/451	91F/451
Compatible fluids		Greases, high viscosity oils	
Suction tube upper body		Carbon steel	
Suction tube		Carbon steel	
Air inlet connection	bsp	F 1/2" G	F 1/2" G
Fluid outlet connection	bsp	F 1/2" G	F 1/2" G
Flow rate	g/min	4400	4400
Max air consumption 8 bar	m ³ /min	1,6	1,6
Noise level	dB	80	80
Air max pressure	bar	8	8
Suitable for drums		 tank	 suitable for drums 180-220 Kg
Packing	N° - m ³	1 - 0,050	1 - 0,070
Weight	Kg	17	19
Dimensions (A - B - C)	cm	44,5 - 50 - 4,5	44,5 - 94 - 4,5

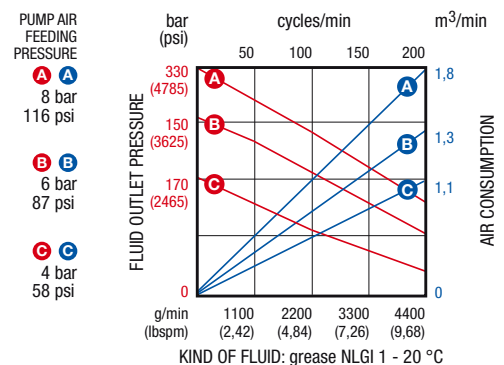
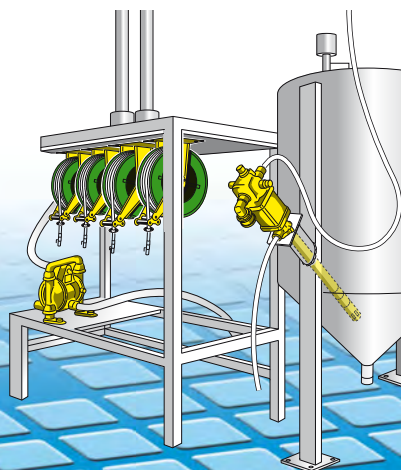

Ratio 70:1
Flow rate **3000 g/min**



Ratio 75:1
Flow rate **4400 g/min**



Ratio 40:1
Flow rate **10000 g/min**



with ram hoist Art.10/85
10/12401P1N

series 900

series 1200

91C/701

116F/751

117F/751

Greases, high viscosity oils

Greases, high viscosity oils

Aluminium

Carbon steel

Carbon steel

F 1/2" G

F 1/2"

F 1/2"

F 1/2" G

F 1/2"

F 1/2"

3000

4400

4400

1,6

2,8

2,8

80

80

80

8

8

8

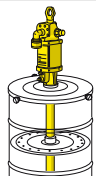

suitable for drums
180-220 Kg

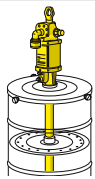

suitable for drums
180-220 Kg

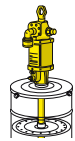

suitable for drums
50-60 Kg

1 - 0,070

1 - 0,070

1 - 0,070

19

21

20

43 - 94 - 4,5

44,5 - 94 - 4,5

44,5 - 74 - 4,5

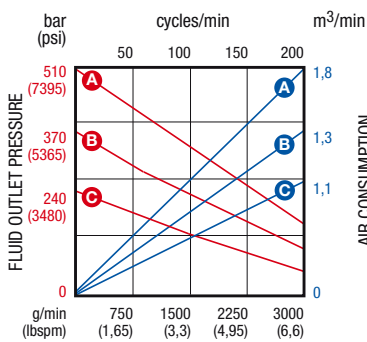

KIND OF FLUID: grease NLGI 1 - 20 °C

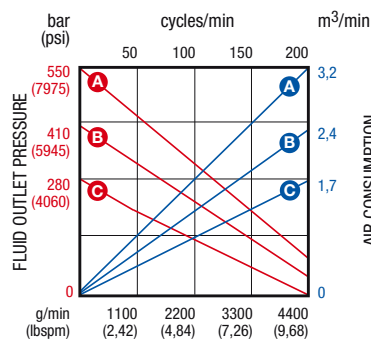

KIND OF FLUID: grease NLGI 1 - 20 °C

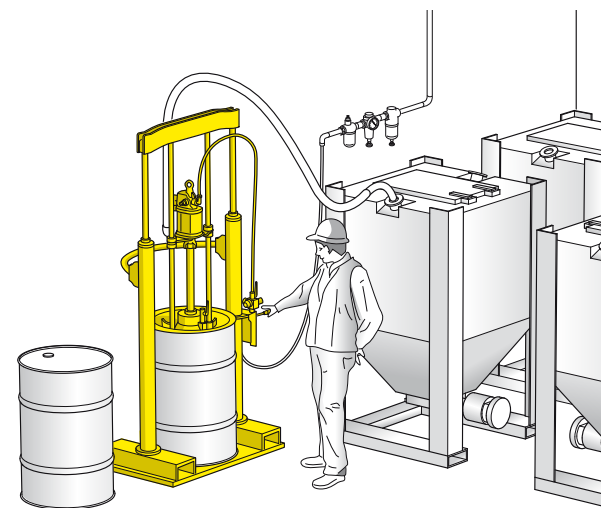



Air-operated INDUSTRIAL PUMPS

grease

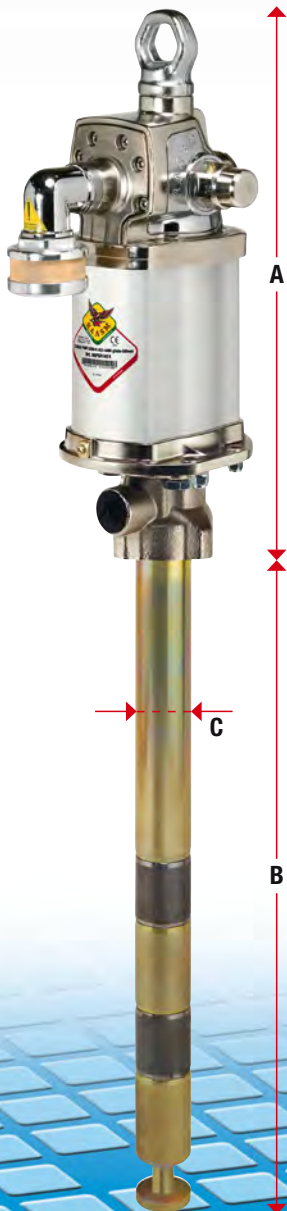

Ratio **45:1**
Flow rate **4400 g/min**

Series 900 - 1200 industrial air-operated pumps for medium-long distance distribution. Suitable for the transfer of medium-high viscosity oils and greases. The high quality of the components ensures lasting and reliable operation even in extreme conditions whereas the double action guarantees the delivery of a continuous and constant flow. Particularly effective in systems equipped with several dispensing points.

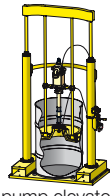
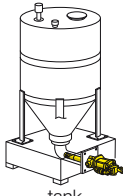

series **900**

flanged

Article with seals in	PU	90FSP/451	90F/451	92F/451	91F/451
Compatible fluids		High viscosity oils and greases			
Suction tube upper body		Carbon steel			
Suction tube		Carbon steel			
Air inlet connection	bsp	F 1/2"	F 1/2"	F 1/2"	F 1/2"
Fluid outlet connection	bsp	F 1/2"	F 1/2"	F 1/2"	F 1/2"
Max. air consumption 8 bar	m ³ /min	1,6	1,6	1,6	1,6
Noise level	dB	80	80	80	80
Air max. feed pressure	bar	8	8	8	8
Suitable for drums or tanks		 pump elevator	 tank	 suitable for drums 50-60 Kg	 suitable for drums 180-220 Kg
Packing	N° - m ³	1 - 0,085	1 - 0,045	1 - 0,070	1 - 0,070
Weight	Kg	16	16	18	19
Dimensions (A - B - C)	cm	44,5 - 50 - 4,5	44,5 - 50 - 4,5	44,5 - 74 - 4,5	44,5 - 94 - 4,5

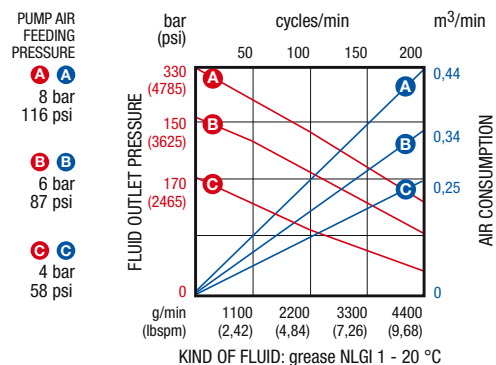

Ratio 70:1
Flow rate **3000 g/min**

Ratio 75:1
Flow rate **4400 g/min**

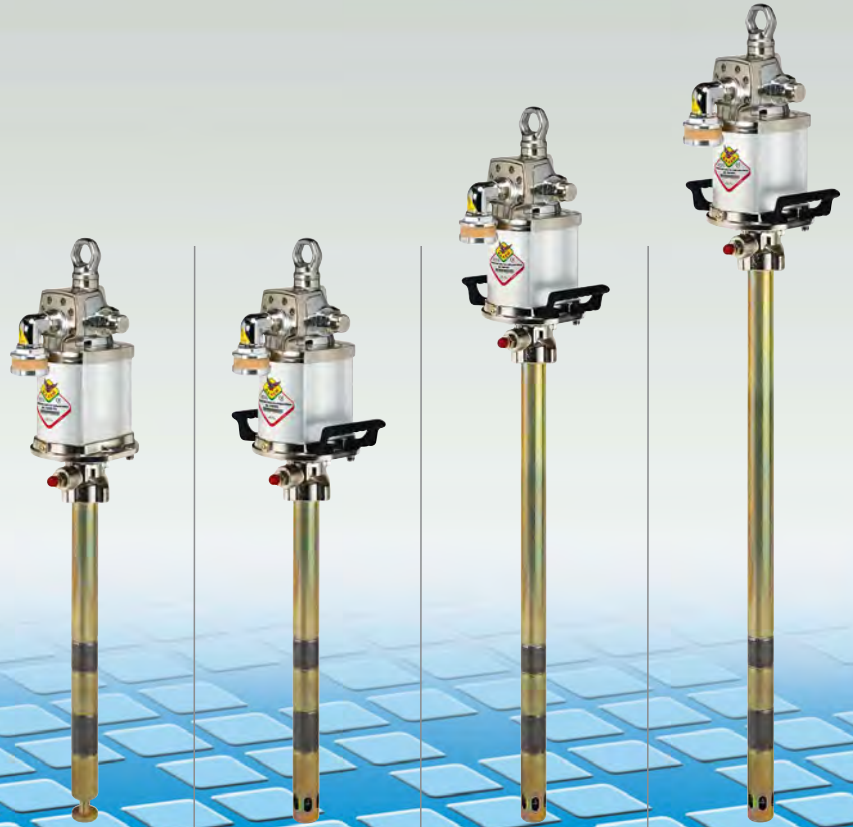

series 900

integral

92C/701

91C/701

High viscosity oils and greases

Aluminium
Carbon steel

F 1/2"

F 1/2"

F 1/2"

F 1/2"

1,6

1,6

80

80

8

8



suitable for drums
50-60 Kg



suitable for drums
180-220 Kg

1 - 0,070

1 - 0,070

18

19

43 - 74 - 4,5

43 - 94 - 4,5

series 1200

flanged

115FSP/751

115F/751

117F/751

116F/751

High viscosity oils and greases

Carbon steel
Carbon steel

F 1/2"

F 1/2"

F 1/2"

F 1/2"

F 1/2"

F 1/2"

F 1/2"

F 1/2"

2,8

2,8

2,8

2,8

80

80

80

80

8

8

8

8

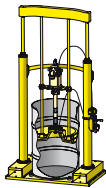

pump elevator

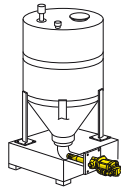

tank

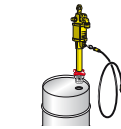

suitable for drums
50-60 Kg

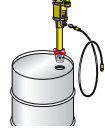

suitable for drums
180-220 Kg

1 - 0,045

1 - 0,045

1 - 0,070

1 - 0,070

18

18

20

21

44,5 - 50 - 4,5

44,5 - 50 - 4,5

44,5 - 74 - 4,5

44,5 - 94 - 4,5

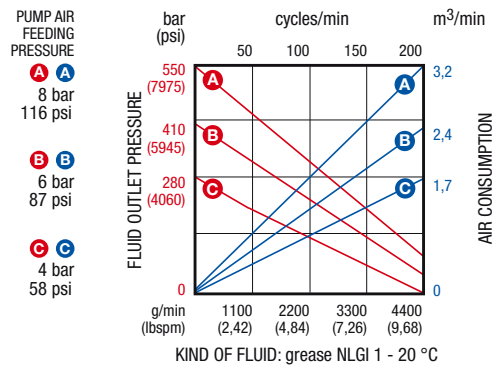
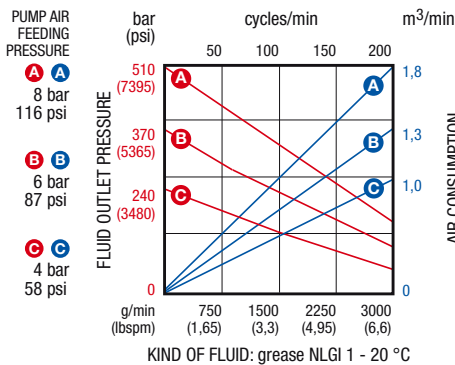

Ratio **70:1**
Flow rate **7000 g/min**



series 1200

flanged

117F/401 **116F/401**

High viscosity oils and greases
Carbon steel
Carbon steel

F 1/2" F 1/2"
F 1/2" F 1/2"
2,8 2,8
80 80
8 8

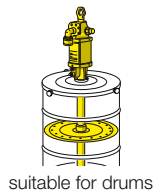
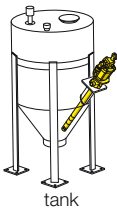

1 - 0,090 1 - 0,090
24 25

44,5 - 86 - 5,08 44,5 - 94 - 5,08

series 1500

flanged

153FSP/701 **153F/701** **150F/701** **152F/701** **151F/701**

High viscosity oils and greases
Carbon steel
Carbon steel

F 1/2" F 1/2" F 1/2" F 1/2" F 1/2"
F 1/2" F 1/2" F 1/2" F 1/2" F 1/2"
4,3 4,3 4,3 4,3 4,3
80 80 80 80 80
8 8 8 8 8

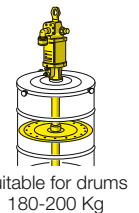
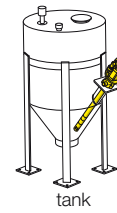
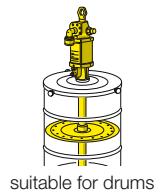
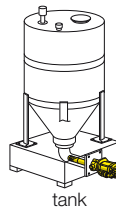
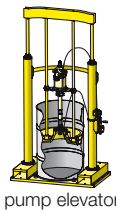

1 - 0,20 1 - 0,20 1 - 0,20 1 - 0,20 1 - 0,20
29 29 31 32 33

50 - 60 - 5,08 50 - 60 - 5,08 50 - 74 - 5,08 50 - 86 - 5,08 50 - 94 - 5,08

