

SQFlex

Renewable-energy based water-supply systems
50/60 Hz



Contents

Product data

Performance range	3
Applications	4
SQFlex system	4
Type keys	5
Pumped liquids	5
Curve conditions	6
System overview	7

Features and benefits

Dry-running protection	8
High efficiency	8
Overvoltage and undervoltage protection	8
Overload protection	8
Overtemperature protection	8
Maximum Power Point Tracking (MPPT)	9
Wide voltage range	9
Reliability	9
Installation	9
Service	9

Application examples

SQFlex Solar	10
SQFlex Wind	14
SQFlex Combi	16
SQFlex system	18

System components

SQF submersible pump	19
CU 200 SQFlex control unit	19
IO 100 SQFlex switch box	21
IO 101 SQFlex switch box	21
IO 102 SQFlex breaker box	22
Charge controller	22
Wind turbine	22
Generator	22

System sizing

Sizing of SQFlex system	23
-------------------------	----

Performance curves

SQF 0.6-2	24
SQF 0.6-3	24
SQF 1.2-2	25
SQF 2.5-2	25
SQF 3A-10	26
SQF 5A-3	26
SQF 5A-6	27
SQF 8A-3	27
SQF 8A-5	28
SQF 11A-3	28

Technical data

Dimensions and weights	29
Electrical data	29
CU 200 SQFlex control unit	30
IO 100 SQFlex switch box	30
IO 101 SQFlex switch box	31
IO 102 SQFlex breaker box	31
Charge controller	31
Material specification, helical rotor pump	32
Material specification, centrifugal pump	33
Material specification, motor	34

Product numbers

SQF submersible pump	35
CU 200 SQFlex control unit	35
IO 100 SQFlex switch box	35
IO 101 SQFlex switch box	35
IO 102 SQFlex breaker box	35
Charge controller	35
Wind turbine	35
Submersible drop cables	35
Water Packages	35

Accessories

Whisper 200 wind turbine	36
Tower kit for Whisper 200	36
Tower installation kit	36
Tower pipe selection	37
Auger/anchor	38
Grease	38
Level switch	38
Anemometer	38
Submersible drop cable	39
Cable termination kit, type KM	39
Cable clips	39
Straining wire	39
Wire clamp	39

Further product documentation

WebCAPS	40
WinCAPS	41

Performance range

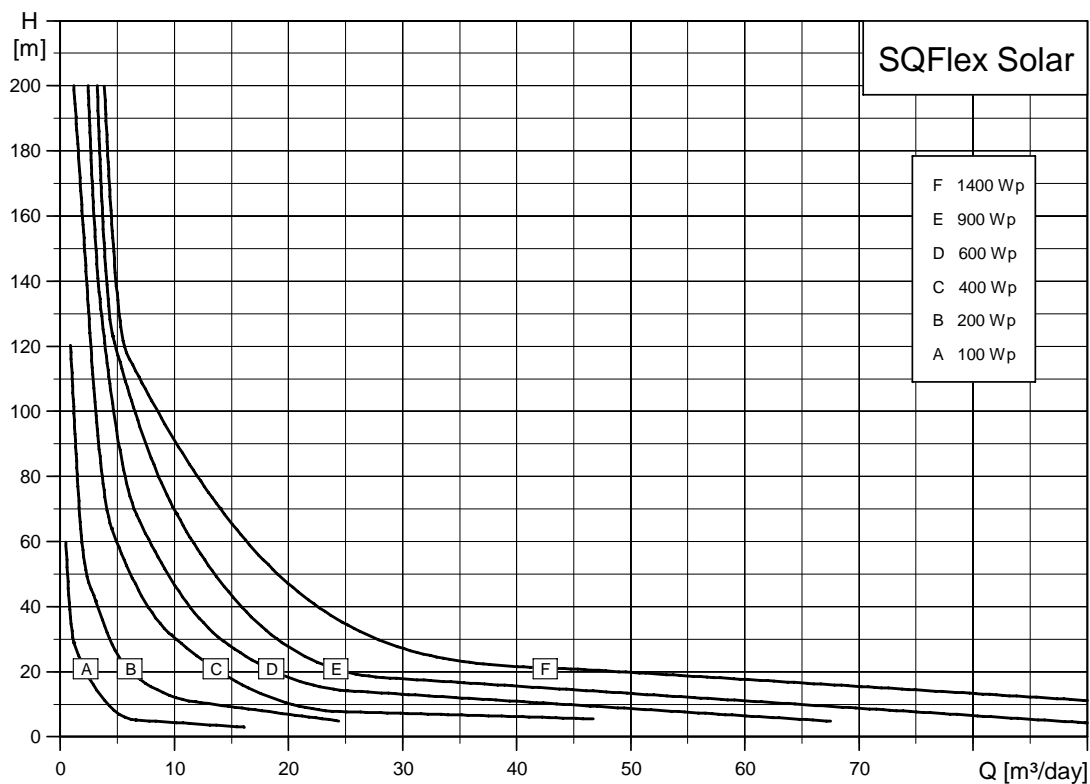

TM02 2337 2206

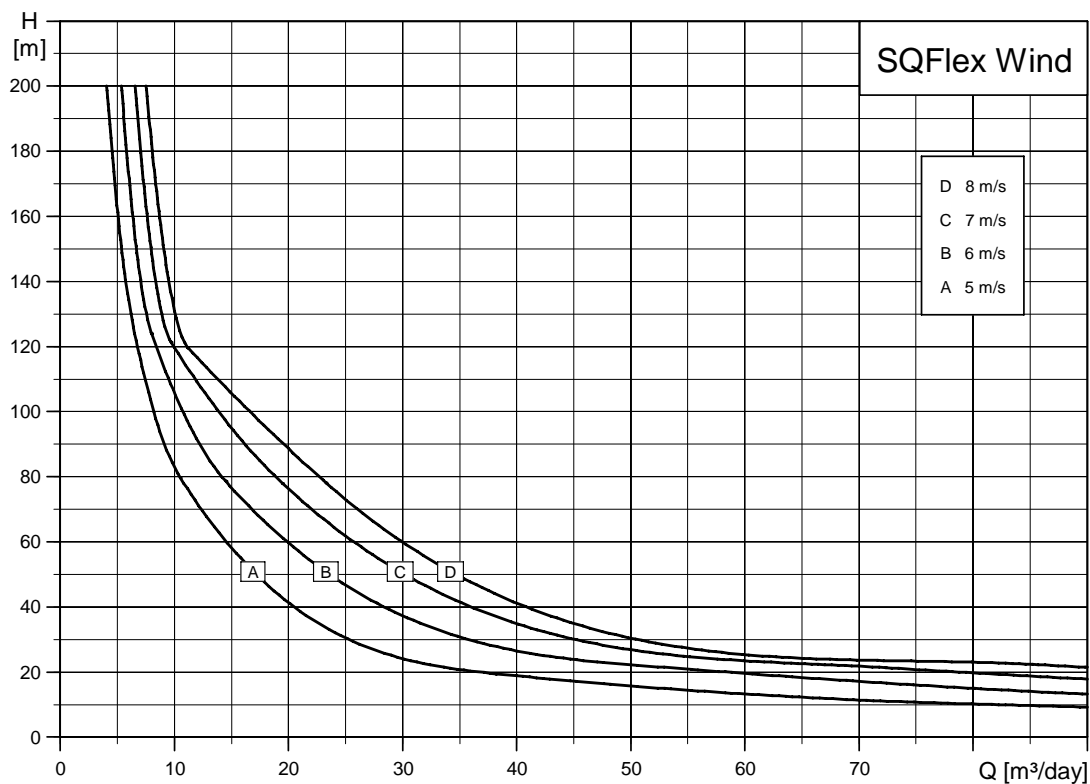

TM02 2411 4201

Note: The curves must not be used as guarantee curves.

Applications

Being designed for continuous as well as intermittent operation, the SQFlex system is especially suitable for water supply applications in remote locations, such as

- villages, schools, hospitals, single-family houses, etc.
- farms
 - watering of cattle
 - irrigation of fields and greenhouses
- game parks and game farms
 - watering applications
- conservation areas
 - surface water pumping
- floating pump installations for pumping of water from ponds and lakes.

SQFlex system

The SQFlex system is a reliable water supply system based on renewable energy sources, such as solar and wind energy. The SQFlex system incorporates an SQF submersible pump.

Very flexible as to its energy supply and performance, the SQFlex system can be combined and adapted to any need according to the conditions on the installation site.

The system components are

- SQF submersible pump
- CU 200 SQFlex control unit
- IO 100 SQFlex switch box
- IO 101 SQFlex switch box
- IO 102 SQFlex breaker box
- charge controller
- energy supply:
 - solar panels
 - wind turbine
 - generator
 - batteries.

Pump

The SQF pump range comprises two pump technologies:

- the helical rotor pump (3") for high heads and small flows.
- the centrifugal pump (4") for low heads and large flows.

The performance curves below illustrate the pump performance for the two pump models.

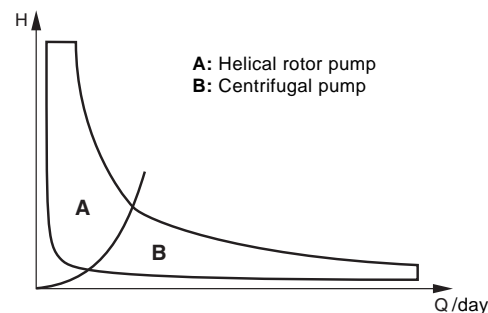

Fig. 1 Performance ranges for helical rotor and centrifugal pumps

All pump types are available in two material variants:

- SQF is the standard version made of stainless steel DIN W.-Nr. 1.4301
- SQF-N is made of stainless steel DIN W.-Nr. 1.4401.

Motor

The motor has been developed specifically for the SQFlex system and is designed according to the permanent-magnet principle with built-in electronic unit.

The SQFlex 3" motor range comprises only two motor sizes, i.e.

- MSF 3 with maximum power input (P_1) of 900 W and
- MSF 3 with maximum power input (P_1) of 1400 W.

The motor speed range is 500-3600 min^{-1} , depending on power input and load.

The motor is available in two material variants:

- MSF 3 is the standard version made of stainless steel DIN W.-Nr. 1.4301
- MSF 3 N is made of stainless steel DIN W.-Nr. 1.4401.

The motor has three internal limitations:

- Maximum power input (P_1) of
 - 900 W (when fitted to helical rotor pumps)
 - 1400 W (when fitted to centrifugal pumps)
- maximum current of 8.4 A
- maximum speed of
 - 3000 min^{-1} (when fitted to helical rotor pumps)
 - 3600 min^{-1} (when fitted to centrifugal pumps).

The pump delivers its maximum performance when one of the above limitations is reached.

Supply voltage

Flexible as regards power supply and power range, the motor can be supplied with either DC or AC voltage:

- 30-300 VDC, PE
- 1 x 90-240 V $-10\%/+6\%$, 50/60 Hz, PE.

TM02 2425 3901

CU 200 SQFlex control unit

The CU 200 is a combined status and control unit for the SQFlex pump system. Moreover, the CU 200 enables connection of a level switch placed in a water reservoir or tank.

IO 100 SQFlex switch box

The IO 100 is an on/off switch box designed for opening and closing the system power supply.

IO 101 SQFlex switch box

The IO 101 is an on/off switch box designed for opening and closing the system power supply.

The IO 101 is used in solar-powered SQFlex systems with a back-up generator.

IO 102 SQFlex breaker box

The IO 102 is an on/off breaker box designed for opening and closing the system power supply.

The IO 102 is used in wind-powered SQFlex systems or wind- and solar-powered SQFlex systems.

The IO 102 makes it possible to slow down or stop the wind turbine.

Charge controller

The charge controller is used when a battery backup system is installed with an SQFlex pumping system.

Solar modules

Grundfos' solar modules have been developed specifically for the SQFlex system. The solar modules are equipped with plugs and sockets enabling easy connection in parallel.

For further information on solar modules, please contact your local Grundfos company.

Generator

In case the power supply from its primary source of energy is temporarily insufficient, the SQFlex system can be powered by a diesel- or petrol-driven generator.

Batteries

The SQFlex system can be powered by batteries with a voltage supply of 30-300 VDC, maximum current 8.4 A.

Type keys

Type key for helical rotor pumps

Example	SQF	1.2	-2	x
Type range				
Rated flow [m ³ /h] at 3000 min ⁻¹				
Number of stages				
Blank = Stainless steel DIN W.-Nr. 1.4301 N = Stainless steel DIN W.-Nr. 1.4401				

Type key for centrifugal pumps

Example	SQF	5A	-3	x
Type range				
Rated flow [m ³ /h] at 3000 min ⁻¹ and pump generation				
Number of stages				
Blank = Stainless steel DIN W.-Nr. 1.4301 N = Stainless steel DIN W.-Nr. 1.4401				

Pumped liquids

SQF pumps are applicable in thin, clean, non-aggressive, non-explosive liquids, not containing solid or long-fibred particles larger than sand grains.

pH value: 5 to 9.

Liquid temperature: 0°C to +40°C.

The pump can run at free convection (~ 0 m/s) at maximum +40°C.

Salt content

Maximum sand content: 50 g/m³.

A higher sand content will reduce the pump life considerably due to wear.

The table below shows the resistance of stainless steel to Cl⁻. The figures in the table are based on a pumped liquid with a pH value of 5 to 9.

Stainless steel DIN W.-Nr.	Cl ⁻ content [ppm]	Liquid temperature [°C]
1.4301	0-300	< 40
	300-500	< 30
1.4401	0-500	< 40

Curve conditions

Performance range, SQFlex Solar

The SQFlex Solar performance range shown on page 3 is based on

- solar radiation on a tilted surface (tilt angle of 20°)
- $H_T = 6 \text{ kWh/m}^2$ per day
- ambient temperature: +30°C
- 20° northern latitude.

Performance range, SQFlex Wind

The SQFlex Wind performance range shown on page 3 is based on

- average wind speed, measured over one month
- calculations according to Weibull's factor $k = 2$
- continuous operation over 24 hours.

Specific performance charts

The specific performance charts on pages 24 to 28 are based on the following guidelines:























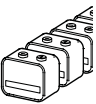



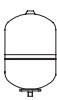









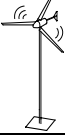

- All curves show mean values.
- The curves must not be used as guarantee curves.
- Typical deviation: $\pm 15\%$.
- The measurements have been made at a water temperature of +20°C.
- The curves apply to a kinematic viscosity of $1 \text{ mm}^2/\text{s}$ (1 cSt). If the pump is used for liquids with a viscosity higher than that of water, this will reduce the head and increase the power consumption.

Pressure loss

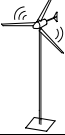
The QH curves are inclusive of inlet and valve losses at actual speed.

System overview

The SQFlex system can be used in a number of combinations as shown in the table below.

System	consists of the following components							
	Pump	Solar panels ★	Wind turbine	Generator/ battery/ power supply	Charge controller	Switch box or breaker box	Control unit	Additional extras
SQFlex Solar See page 10.						 IO 100		
SQFlex Solar - with CU 200 and level switch See page 11.							 CU 200	 (★★)
SQFlex Solar - with back-up generator See page 12.						 IO 101		
SQFlex Solar - with back-up batteries See page 13.						 IO 100 or IO 101 (★★)	 CU 200	 Pressure tank  Pressure switch
SQFlex Wind See page 14.						 IO 102		
SQFlex Wind - with CU 200 and level switch See page 15.						 IO 102	 CU 200	 (★★)
SQFlex Combi - combination of solar and wind energy See page 16.						 IO 102		
SQFlex Combi - with CU 200 and level switch See page 17.						 IO 102	 CU 200	 (★★)
SQFlex system - with generator as power supply See page 18.						 IO 101		

★ For number of solar modules required, please consult the sizing tool in Grundfos WinCAPS.

★★ Optional.

Dry-running protection

The SQF pump is protected against dry running in order to prevent damage to the pump. The dry-running protection is activated by a water level electrode placed on the motor cable 0.3 - 0.6 m above the pump, depending on pump type.

The water level electrode measures the contact resistance to the motor sleeve through the water. When the water level falls below the water level electrode, the pump will be cut out. The pump will automatically cut in again 5 minutes after the water level is above the water level electrode.

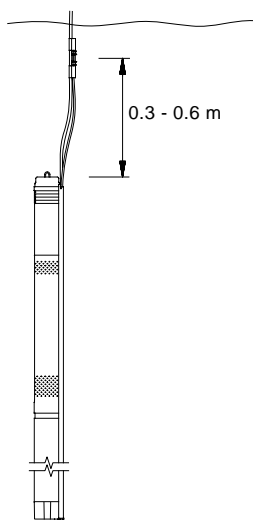

Fig. 2 Vertical installation

TM02 2436 3901

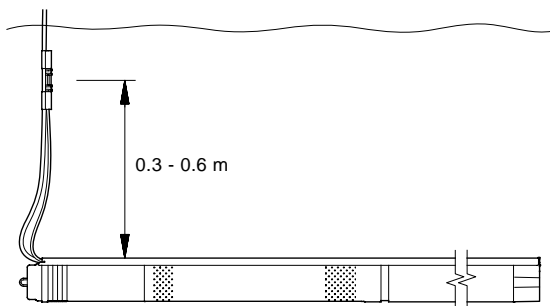

Fig. 3 Horizontal installation

TM02 2435 3901

High efficiency

The MSF 3 motor is a permanent-magnet motor (PM motor) featuring a higher efficiency within the power range compared to a conventional asynchronous motor.

In addition to this, the segmented motor stator contributes considerably to the high efficiency.

The MSF 3 motor is furthermore characterised by a high locked-rotor torque even at low power supply.

Overvoltage and undervoltage protection

Overvoltage and undervoltage may occur in case of unstable power supply or a faulty installation.

The pump will be cut out if the voltage falls outside the permissible voltage range. The motor is automatically cut in when the voltage is again within the permissible voltage range. Therefore no extra protection relay is needed.

Note: The MSF 3 motor is protected against transients from the power supply according to IEC 60664-1 "overvoltage category III" (4 kV). In areas with high lightning intensity, external lightning protection is recommended.

Overload protection

In case the upper load limit is exceeded, the motor will automatically compensate for this by reducing the speed. If the speed falls below 500 min^{-1} , the motor will be cut out automatically.

The motor will remain cut out for 10 seconds after which period the pump will automatically attempt to restart.

The overload protection prevents burnout of the motor. Consequently, no extra motor protection is required.

Overtemperature protection

A permanent-magnet motor gives off very little heat to its surroundings. In combination with an efficient internal circulation system leading the heat away from the rotor, stator and bearings, this fact ensures optimum operating conditions for the motor.

As an extra protection, the electronic unit has a built-in temperature sensor. When the temperature rises above $+85^\circ\text{C}$, the motor is automatically cut out. When the temperature has dropped to $+75^\circ\text{C}$, the motor is automatically cut in again.

Maximum Power Point Tracking (MPPT)

The built-in electronic unit gives the SQFlex system a number of advantages compared to conventional products. One of these advantages is the built-in micro-processor with MPPT (MPPT = **Maximum Power Point Tracking**).

Thanks to the MPPT-function, the pump duty point is continuously optimised according to the input power available. MPPT is only available for pumps connected to DC supply.

Wide voltage range

The wide voltage range enables the motor to operate at any voltage from 30-300 VDC or 90-240 VAC. This makes installation and sizing especially easy.

Reliability

The MSF 3 motor has been developed with a view to high reliability which is achieved through the following features:

- carbon/ceramic bearings
- excellent starting capabilities
- various protection facilities.

Installation

The following features ensure simple installation of the SQF pump:

- low weight ensuring user-friendly handling
- installation in 3", 4" or larger boreholes
- only an on/off switch is needed, which means that no extra motor starter / starter box is necessary
- SQF is available with cable and socket.

Note: Horizontal installation requires the water level electrode to be placed min. 0.3 to 0.6 m above the pump to ensure the dry-running protection.

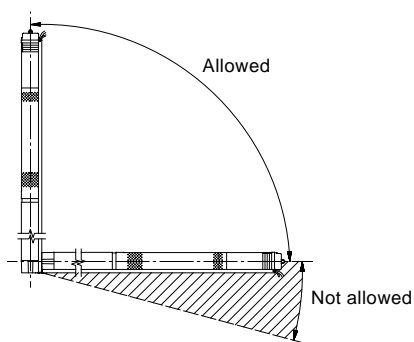

Fig. 4 Installation of SQF pumps

TM02 2246 3901

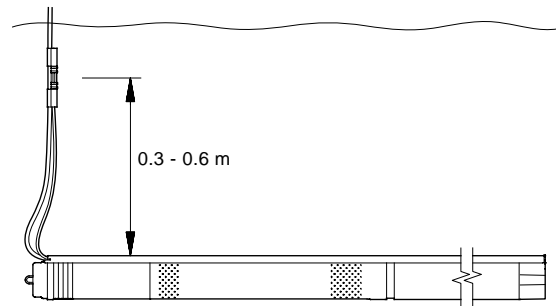

Fig. 5 Horizontal installation

TM02 2435 3901

Service

The modular pump and motor design facilitates installation and service. The cable and the end cover with socket are fitted to the pump with screws which enable replacement.

SQFlex Solar

The SQFlex Solar system is the simplest of the range of SQFlex systems.

Benefits

- Easy to install
- Maintenance confined to periodic cleaning of the solar panels
- Few and simple components.

The protective circuit incorporated in the motor electronic unit cuts out the pump in case of dry running or similar situations.

By using the IO 100, the power supply to the pump can be closed manually, for example when

- there is no need for water supply
- the system requires service.

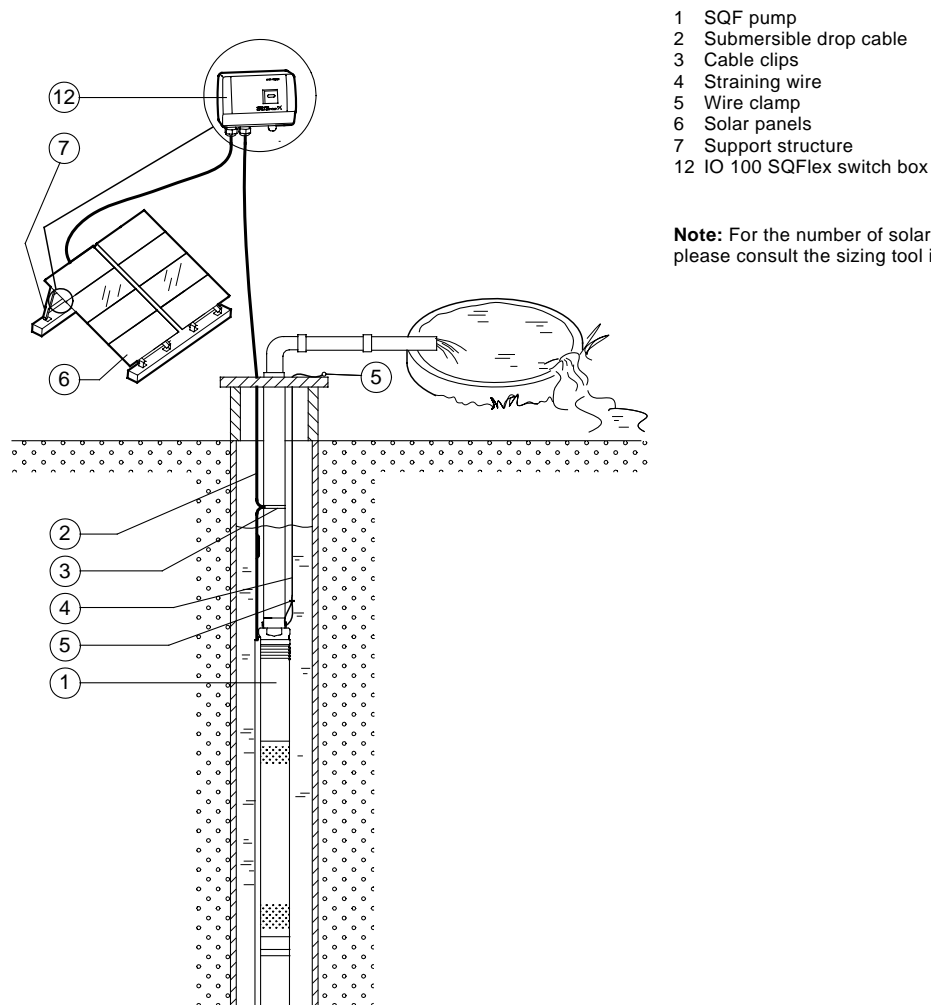

Note: For the number of solar modules required, please consult the sizing tool in Grundfos WinCAPS.

Fig. 6 SQFlex Solar

TM02 2304 4101

SQFlex Solar

- with CU 200 and level switch

The SQFlex Solar system allows solar energy to be stored as water in a reservoir.

SQFlex Solar water supply systems with a water reservoir are used where

- there is a need for water supply at night
- for short periods, the solar energy is insufficient to run the pump
- there is a need for a back-up water source.

Benefits

Combined with the CU 200, the level switch acts as a pump cut-out function when the water reservoir is full.

The CU 200 offers indication of

- full water reservoir (level switch activated)
- pump operation
- input power.

The CU 200 indicates operational stoppage in case of

- dry running
- service (see page 19)
- insufficient energy supply.

In addition, the system features

- easy installation
- maintenance confined to periodic cleaning of the solar panels.

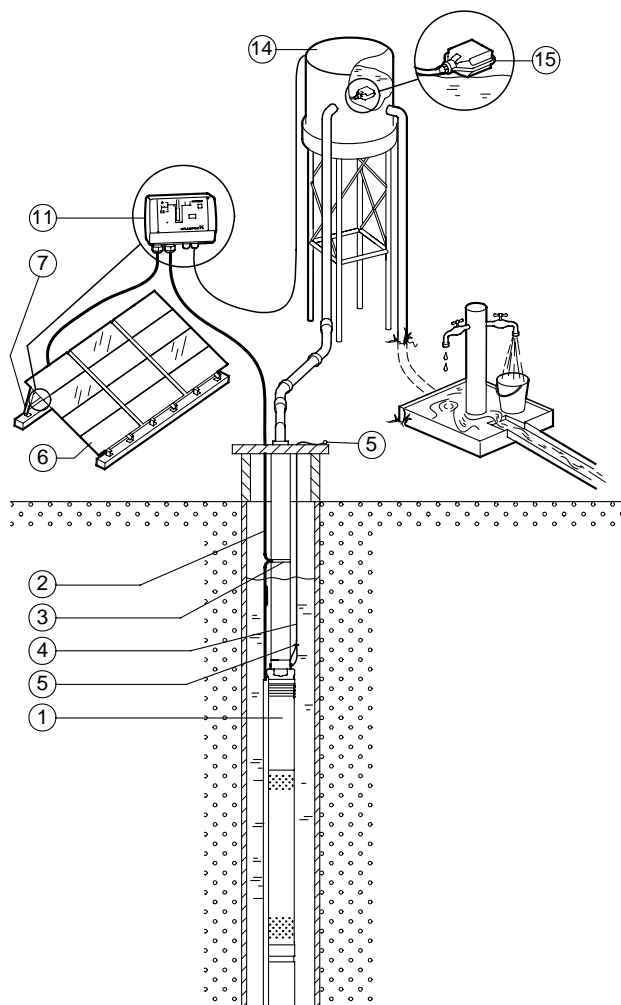

- 1 SQF pump
- 2 Submersible drop cable
- 3 Cable clips
- 4 Straining wire
- 5 Wire clamp
- 6 Solar panels
- 7 Support structure
- 11 CU 200 SQFlex control unit
- 14 Water reservoir
- 15 Level switch

Note: For the number of solar modules required, please consult the sizing tool in Grundfos WinCAPS.

Fig. 7 SQFlex Solar with CU 200 and level switch

TM02 2305 4101

SQFlex Solar

- with back-up generator

During periods of limited solar energy, the SQFlex Solar water supply system provides reliable water supply. The system is connected to an external back-up generator via the IO 101.

The system switches automatically to operation

- via generator when
 - the energy supply from the solar panels is insufficient
- via solar panels when
 - the generator is stopped manually or
 - the generator runs out of fuel.

Benefits

The system offers water supply during the night or during periods of insufficient solar energy.

Other benefits of the system include

- easy to install
- maintenance confined to periodic cleaning of the solar panels
- few and simple components
- flexible in terms of energy supply.

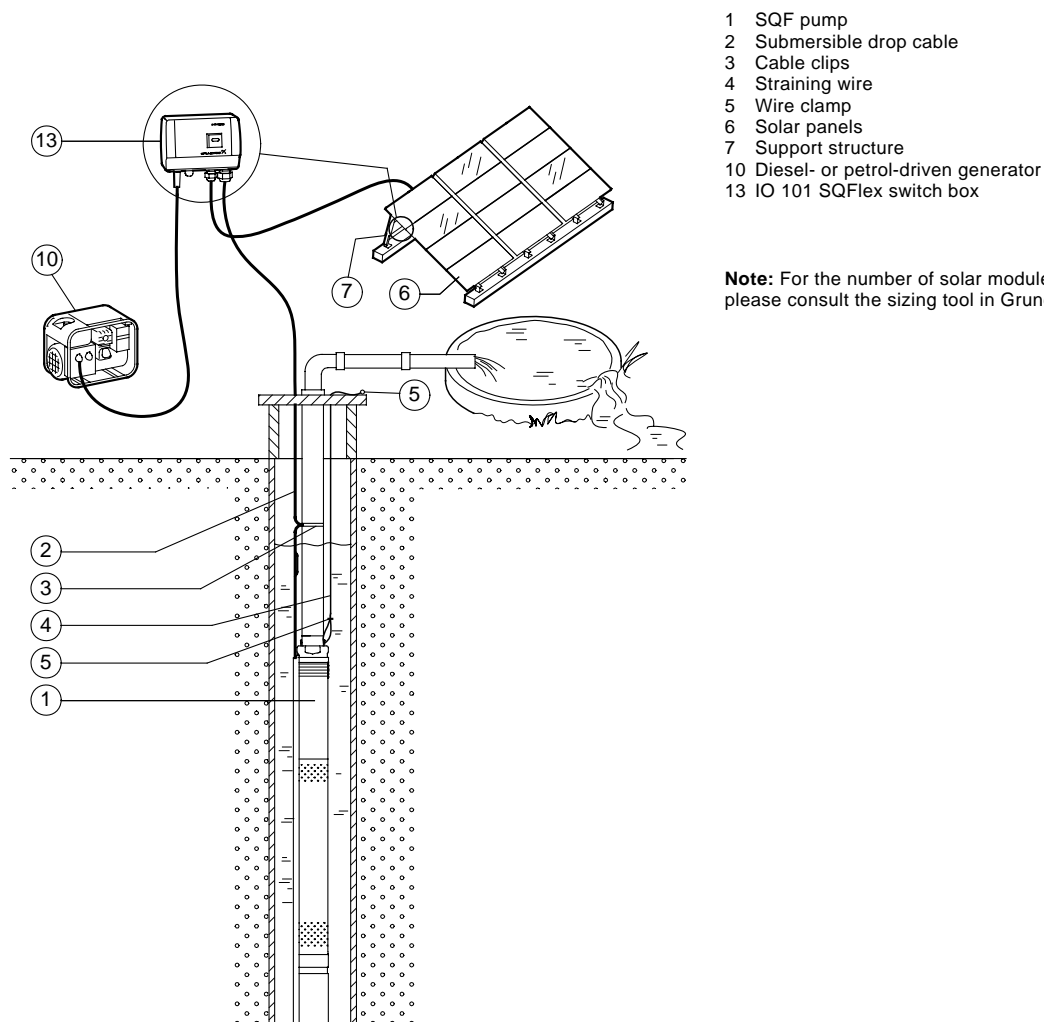

Note: For the number of solar modules required, please consult the sizing tool in Grundfos WinCAPS.

Fig. 8 SQFlex Solar with back-up generator

TM02 2309 4101

SQFlex Solar

- with back-up batteries

During periods of limited solar energy, the SQFlex Solar system provides reliable water supply.

The supply of water is ensured by back-up batteries connected to the system via the charge controller.

The system is connected as shown in fig. 9.

- Power will be provided by the solar panels wired to produce 48-110 VDC (rated).
- Power from the solar panels will feed into a 48 VDC charge controller, which will regulate the current fed to the batteries.
- From the charge controller, power passes into the battery bank, which consists of the number of appropriately sized batteries, wired in series to achieve 48 VDC (rated) output.

- Power is drawn from the battery bank and routed through a CU 200.
- **Option:** An IO 100 or IO 101 is to be installed to enable disconnection of the DC voltage. If an IO 101 is installed, it is possible to add a generator to the system.
- Power is run from the CU 200 to the SQFlex pump.

Benefits

The system offers water supply during the night or during periods of insufficient solar energy.

Other benefits of the system include

- easy installation
- a minimum of maintenance
- few and simple components
- flexibility in terms of energy supply.

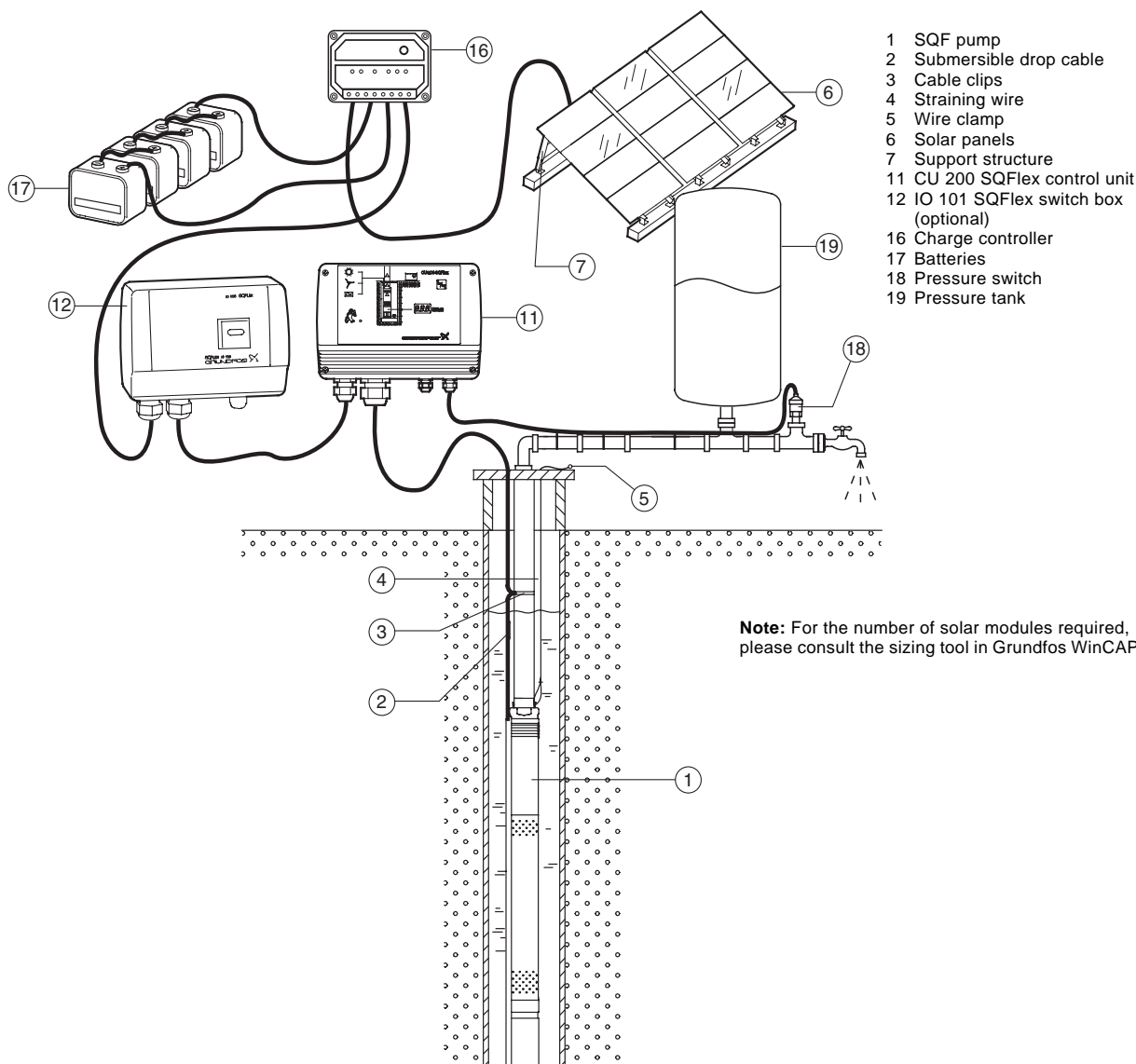

Fig. 9 SQFlex Solar with back-up batteries

TM03 4232 1906

SQFlex Wind

The SQFlex Wind system is based on wind energy as the only energy source for pump operation.

The system is suitable for installation in areas where the wind is almost constant seen over a period of time.

As the turbine noise level increases with the wind speed, installation of the wind turbine near a residence is not recommended.

The IO 102 makes it possible to slow down the wind turbine when

- there is no need for water supply
- the system requires service.

Benefits

- Easy to install
- A minimum of maintenance
- Few and simple components.

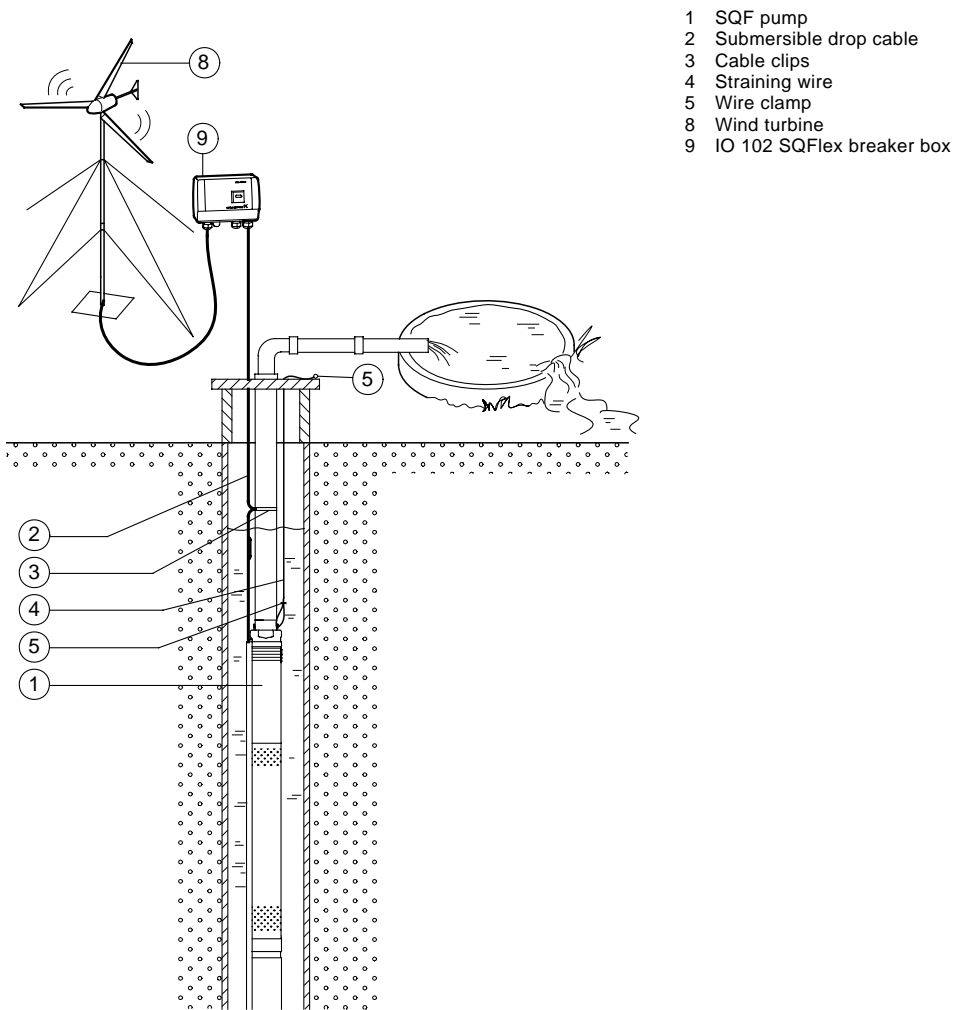

Fig. 10 SQFlex Wind

TM02 2306 4101

SQFlex Wind

- with CU 200 and level switch

The SQFlex Wind system allows wind energy to be stored as water in a reservoir.

SQFlex Wind water supply systems with a water reservoir are used where

- for short periods, the wind energy is insufficient to run the pump
- there is a need for a back-up water source.

As the turbine noise level increases with the wind speed, installation of the wind turbine near a residence is not recommended.

Benefits

Combined with the CU 200, the level switch acts as a pump cut-out function when the water reservoir is full.

The CU 200 offers indication of

- full water reservoir (level switch activated)
- pump operation
- input power.

The CU 200 indicates operational stoppage in case of

- dry running
- service (see page 19)
- insufficient energy supply.

The IO 102 makes it possible to switch off the power supply in the system and to slow down or stop the wind turbine when

- there is no need for water supply
- the system requires service.

Other benefits of the system include

- easy installation
- a minimum of maintenance.

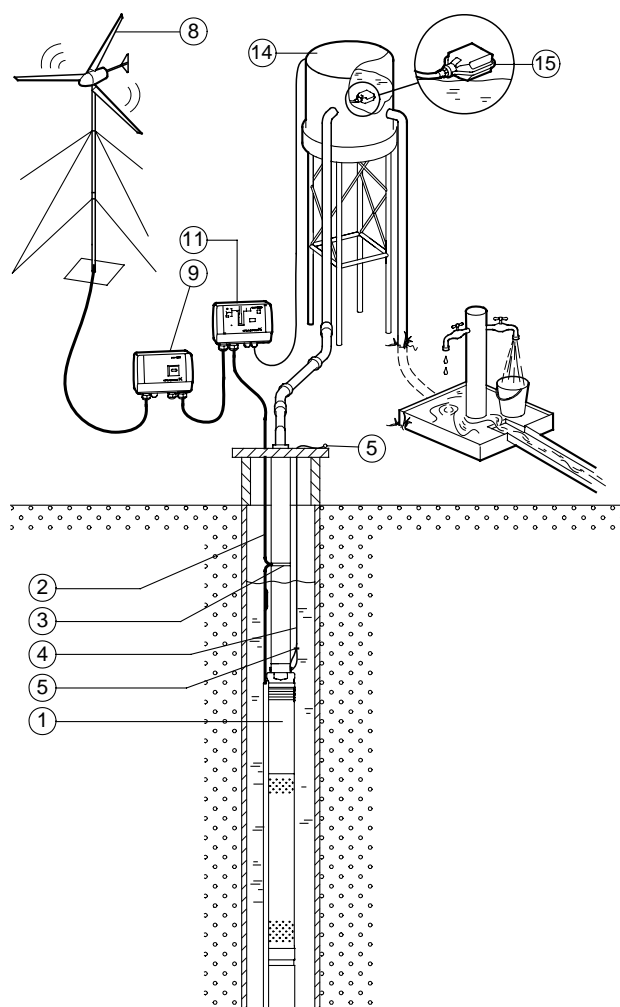

- 1 SQF pump
- 2 Submersible drop cable
- 3 Cable clips
- 4 Straining wire
- 5 Wire clamp
- 8 Wind turbine
- 9 IO 102 SQFlex breaker box
- 11 CU 200 SQFlex control unit
- 14 Water reservoir
- 15 Level switch

Fig. 11 SQFlex Wind with CU 200 and level switch

TM02 2308 4101

SQFlex Combi

- combination of solar and wind energy

The SQFlex Combi water supply system is ideal in areas where the solar and/or wind energy is sufficient to run the pump.

The energy supply to the pump is a combination of solar and wind energy.

As the turbine noise level increases with the wind speed, installation of the wind turbine near a residence is not recommended.

Benefits

The system offers water supply during the night or during periods of insufficient solar energy.

Other benefits of the system include

- easy to install
- maintenance confined to periodic cleaning of the solar panels
- few and simple components.

The IO 102 makes it possible to switch off the power supply in the system and to slow down or stop the wind turbine when

- there is no need for water supply
- the system requires service.

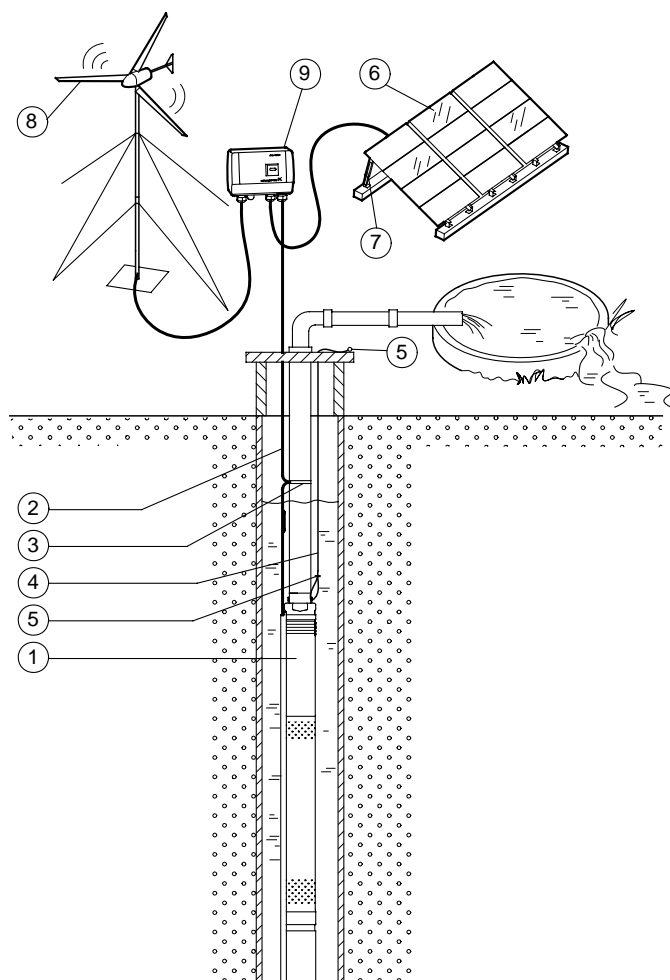

- 1 SQF pump
- 2 Submersible drop cable
- 3 Cable clips
- 4 Straining wire
- 5 Wire clamp
- 6 Solar panels
- 7 Support structure
- 8 Wind turbine
- 9 IO 102 SQFlex breaker box

Note: For the number of solar modules required, please consult the sizing tool in Grundfos WinCAPS.

Fig. 12 SQFlex Combi – combination of solar and wind energy

TM02 2307 4101

SQFlex Combi

- with CU 200 and level switch

The SQFlex Combi system allows solar and wind energy to be stored as water in a reservoir.

SQFlex Combi water supply systems with a water reservoir are used where

- for short periods, the solar or wind energy is insufficient to run the pump
- there is a need for a back-up water source.

As the turbine noise level increases with the wind speed, installation of the wind turbine near a residence is not recommended.

Benefits

Combined with the CU 200, the level switch acts as a pump cut-out function when the water reservoir is full.

The CU 200 offers indication of

- full water reservoir (level switch activated)
- pump operation
- input power.

The CU 200 indicates operational stoppage in case of

- dry running
- service (see page 19)
- insufficient energy supply.

The IO 102 makes it possible to switch off the power supply in the system and to slow down or stop the wind turbine when

- there is no need for water supply
- the system requires service.

Other benefits of the system include

- easy installation
- a minimum of maintenance.

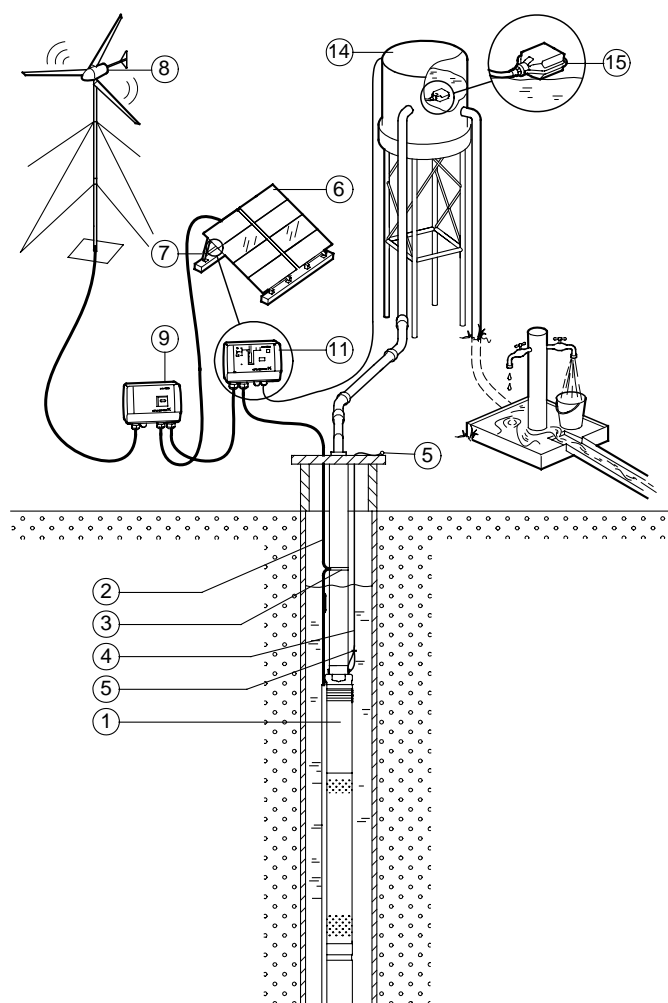

- 1 SQF pump
- 2 Submersible drop cable
- 3 Cable clips
- 4 Straining wire
- 5 Wire clamp
- 6 Solar panels
- 7 Support structure
- 8 Wind turbine
- 9 IO 102 SQFlex breaker box
- 11 CU 200 SQFlex control unit
- 14 Water reservoir
- 15 Level switch

Note: For the number of solar modules required, please consult the sizing tool in Grundfos WinCAPS.

Fig. 13 SQFlex Combi with CU 200 and level switch

TM02 2310 4101

SQFlex system

- with generator as power supply

The SQFlex water supply system is connected to a diesel- or petrol-driven generator.

Benefits

The system offers water supply 24 hours a day, independently of the weather.

Other benefits of the system include

- easy installation
- a minimum of maintenance required
- few and simple components.

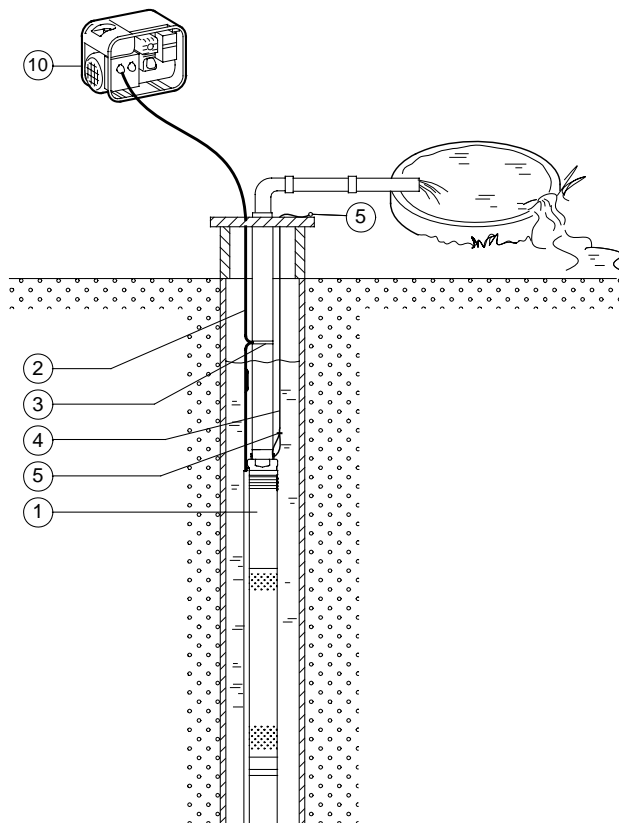

- 1 SQF pump
- 2 Submersible drop cable
- 3 Cable clips
- 4 Straining wire
- 5 Wire clamp
- 10 Generator

Fig. 14 SQFlex system with generator as power supply

TM02 2311 4101

SQF submersible pump

The SQF pump is available as a complete unit only.

The SQF pump complete comprises

- motor
- 2.0 m cable with water level electrode and socket
- cable guard.

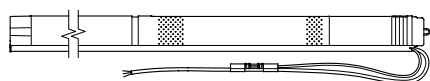

TM02 2217 3901

Fig. 15 SQF pump

The MSF motor is to be connected to the power supply as shown in fig. 16.

As the integrated electronic unit enables the motor to handle both DC and AC supply voltages, it makes no difference how the wires "+" and "-" or "N" and "L" are connected.

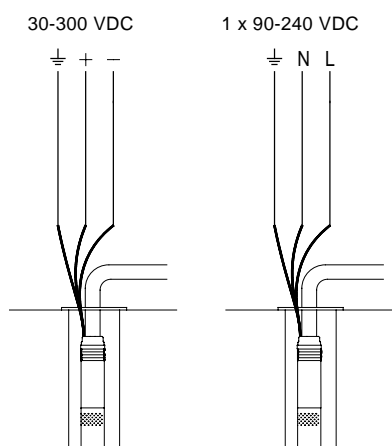

TM02 2437 3901

Fig. 16 Wiring diagram

CU 200 SQFlex control unit

The CU 200 is a combined status, control and communication unit especially developed for the SQFlex system. The CU 200 also enables connection of a level switch.

The CU 200 incorporates cable entries for

- power supply connection (pos. 6)
- pump connection (pos. 7)
- earth connection (pos. 8)
- level switch connection (pos. 9).

(The position numbers in brackets refer to fig. 17.)

Communication between the CU 200 and the pump takes place via the pump power supply cable. This is called mains borne signalling (or Power Line Communication), and this principle means that no extra cables between the CU 200 and the pump are required.

It is possible to start, stop and reset the pump with the on/off button (pos. 1).

The CU 200 offers

- system monitoring
- alarm indication.

The following indications allow the operation of the pump to be monitored:

- water reservoir is full (level switch) (pos. 2)
- pump is running (pos. 3)
- input power (pos. 11).

The CU 200 offers the following alarm indications:

- Dry running (pos. 10)
- Service needed (pos. 5) in case of
 - no contact to pump
 - overvoltage
 - overtemperature
 - overload.

In addition, the CU 200 shows the symbols of the energy supply options (pos. 4).

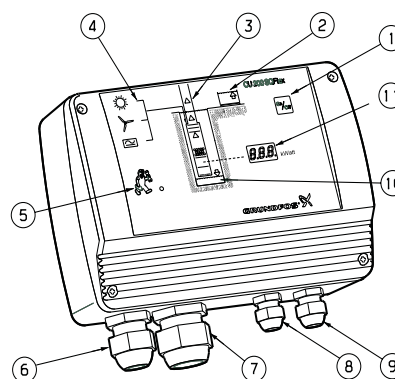

TM02 2325 1206

Fig. 17 CU 200 elements

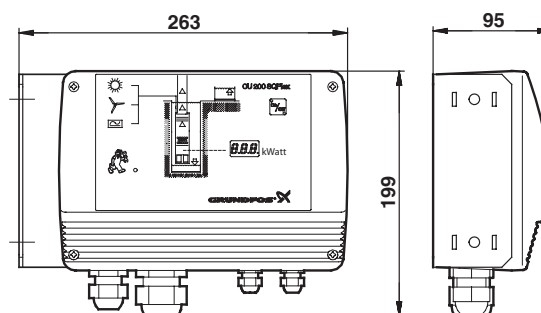

Dimensions stated in mm.

Fig. 18 Dimensions

TM02 2323 1206

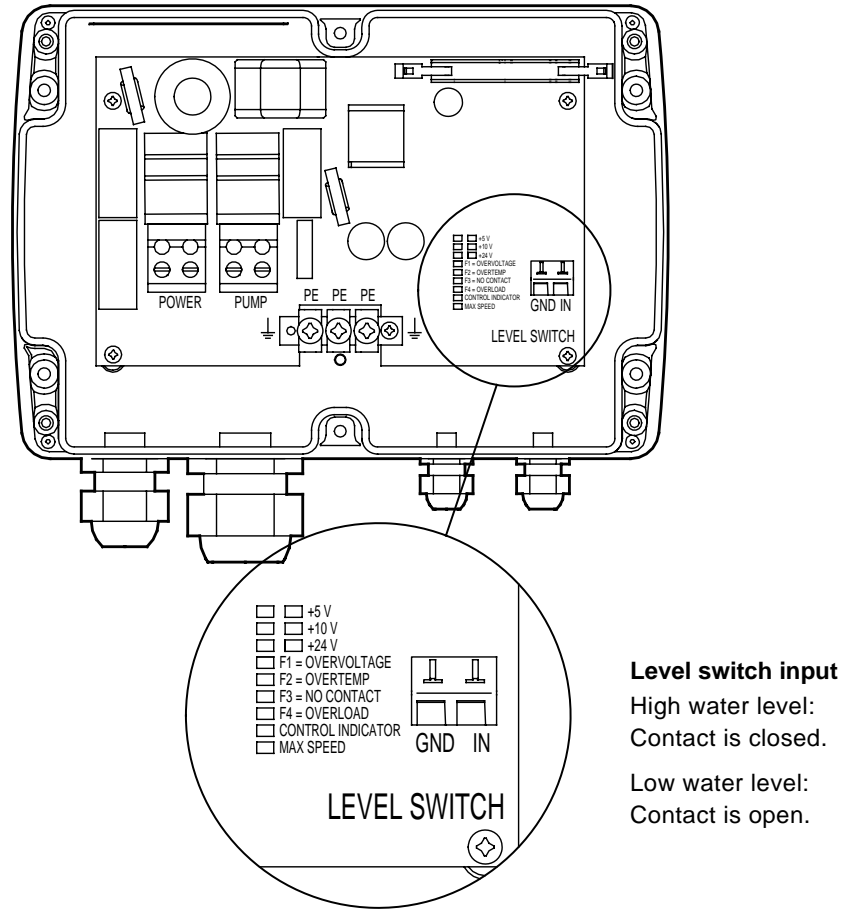

Fig. 19 Electrical connections, CU 200

TM02 2515 4401

IO 100 SQFlex switch box

The IO 100 is designed specifically for solar-powered SQFlex systems.

The IO 100 enables manual starting and stopping of the pump in an SQFlex Solar system and functions as a connection box joining all necessary cables.

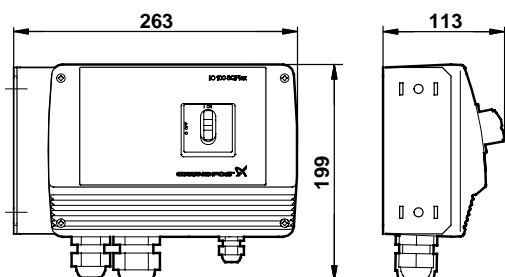

TM02 2545 4003

Dimensions stated in mm.

Fig. 20 Dimensions

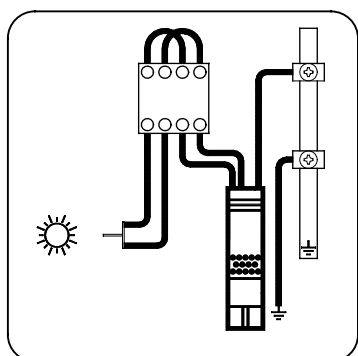

TM02 4058 4701

Fig. 21 Wiring diagram

IO 101 SQFlex switch box

The IO 101 is designed specifically for solar-powered SQFlex systems.

The IO 101 enables the connection of a back-up generator in case of insufficient solar energy. The switching between solar power and generator must be made manually.

In case the generator is stopped manually or runs out of fuel, the IO 101 will automatically change over to the solar panels.

The IO 101 functions as a connection box joining all necessary cables.

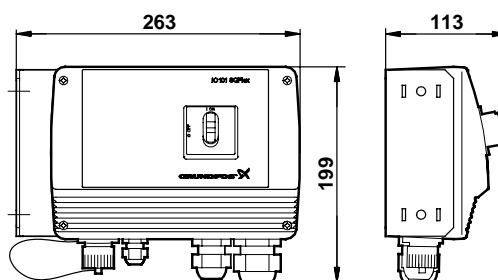

TM02 2546 4003

Dimensions stated in mm.

Fig. 22 Dimensions

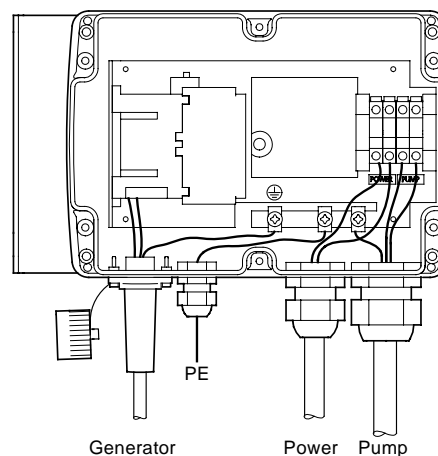

TM02 4162 5001

Fig. 23 Electrical connections

IO 102 SQFlex breaker box

The IO 102 is designed specifically for wind-powered SQFlex systems.

The IO 102 enables manual starting and stopping of the pump in an SQFlex Wind system or an SQFlex Combi system.

The on/off switch has a built-in "electrical brake" for the turbine. When the switch is in "off" position, the turbine stops or slows down.

The IO 102 rectifies the three-phase AC voltage from the wind turbine into DC voltage. Furthermore, the IO 102 enables the combination of wind energy from the wind turbine and solar energy from the solar panels.

The IO 102 functions as a connection box joining all necessary cables.

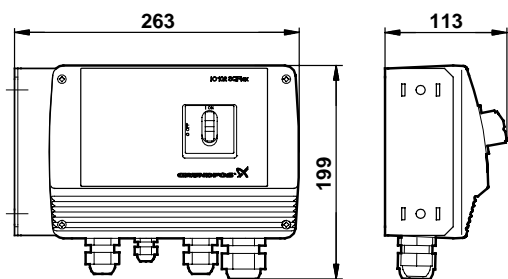

Dimensions stated in mm.

Fig. 24 Dimensions

TM02 4232 4003

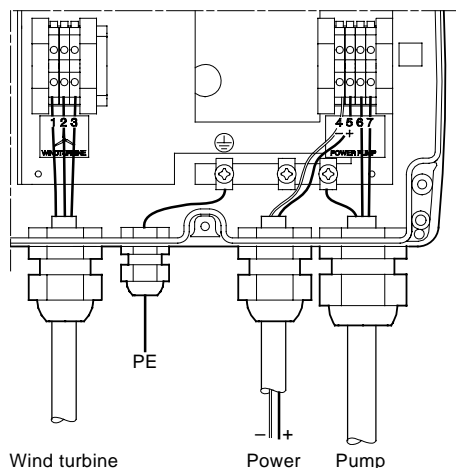

Fig. 25 Electrical connections

TM02 4312 0502

Charge controller

The charge controller is used when a battery backup system is installed with an SQFlex pumping system. These systems are typically used in applications where the pump is not running during most of the peak sun hours of the day, or where it is impossible or impractical to store large volumes of water. Examples include remote homes or cabins, automatic livestock waterers and very low-yielding wells.

The charge controller is a fully automatic battery charger and the only setting required is the selection of battery type.

There are three battery types to choose from:

- gel battery
- sealed battery
- flooded battery.

The charge controller enables manual disconnection of the pump, the solar modules or both at the same time.

Wind turbine

Grundfos offers a Whisper 200 wind turbine.

The IO 102 functions as a breaker box and must be included in wind-powered SQFlex systems.

Note: The IO 102 must be ordered separately.

Generator

The generator can be either diesel- or petrol-driven.

The generator must be running steadily before the pump is cut in.

Sizing of SQFlex system

Grundfos has developed a PC-based sizing tool enabling the sizing of SQFlex systems.

The sizing tool is integrated in Grundfos WinCAPS and covers both solar- and wind-powered systems.

The following three parameters must be known for the sizing of the optimum SQFlex system:

- installation location
- maximum head required
- quantity of water required.

With a view to the sizing of a correct solar-powered SQFlex system, the world has been divided into six regions:

- North America
- South America
- Australia/New Zealand
- Asia/Pacific
- Southern Africa
- Europe/Middle East/Northern Africa.

Each region is divided into a number of zones according to the solar radiation in kWh/m² per day.

SQF 0.6-2

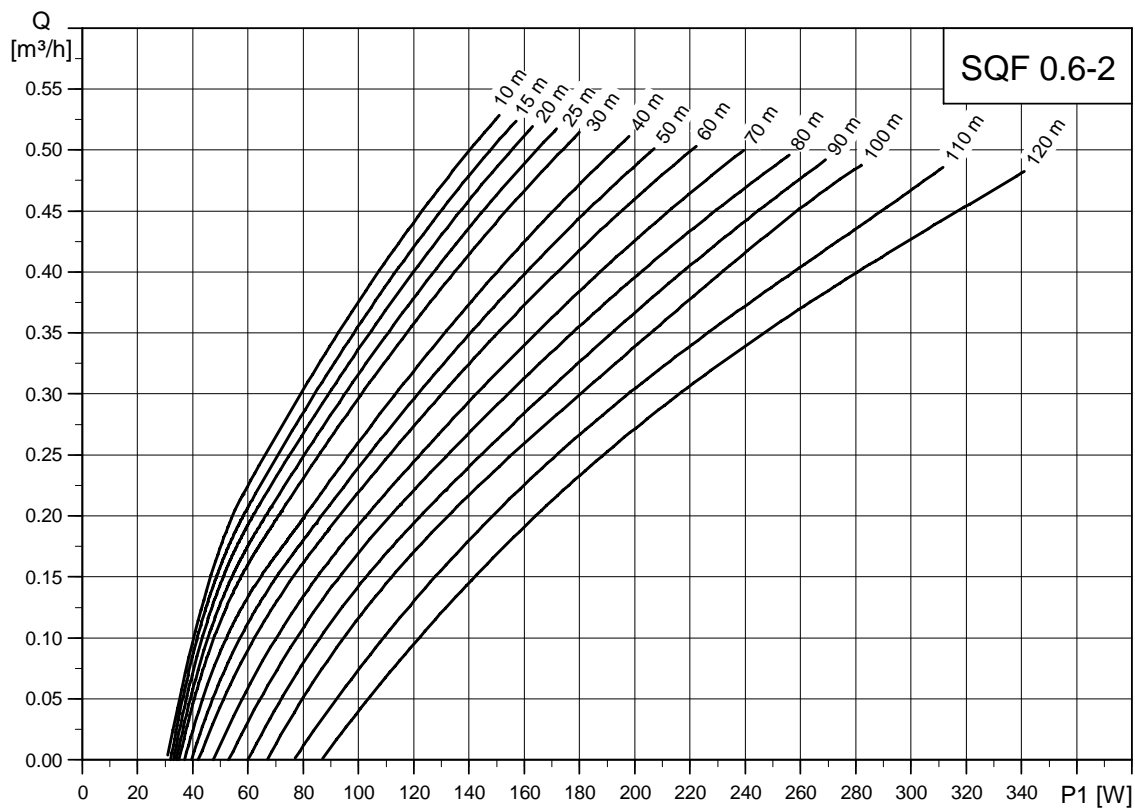

TM02 2338 1206

SQF 0.6-3

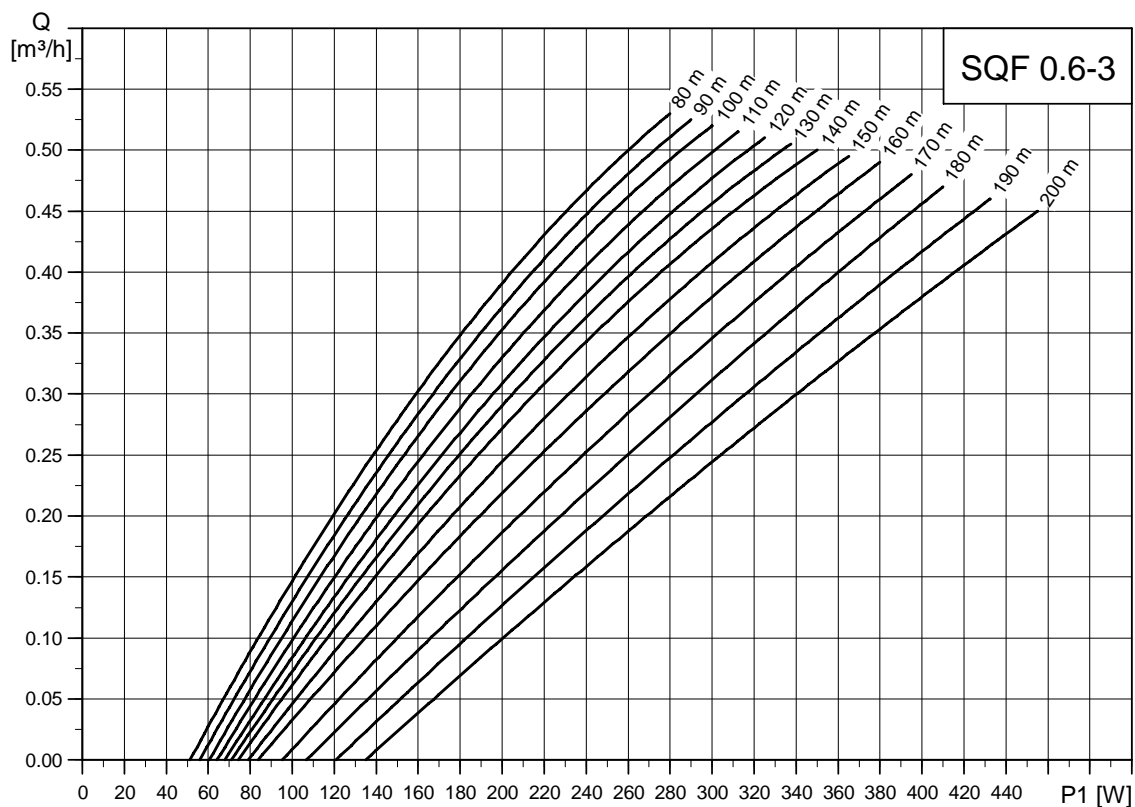

TM03 3926 1206

SQF 1.2-2

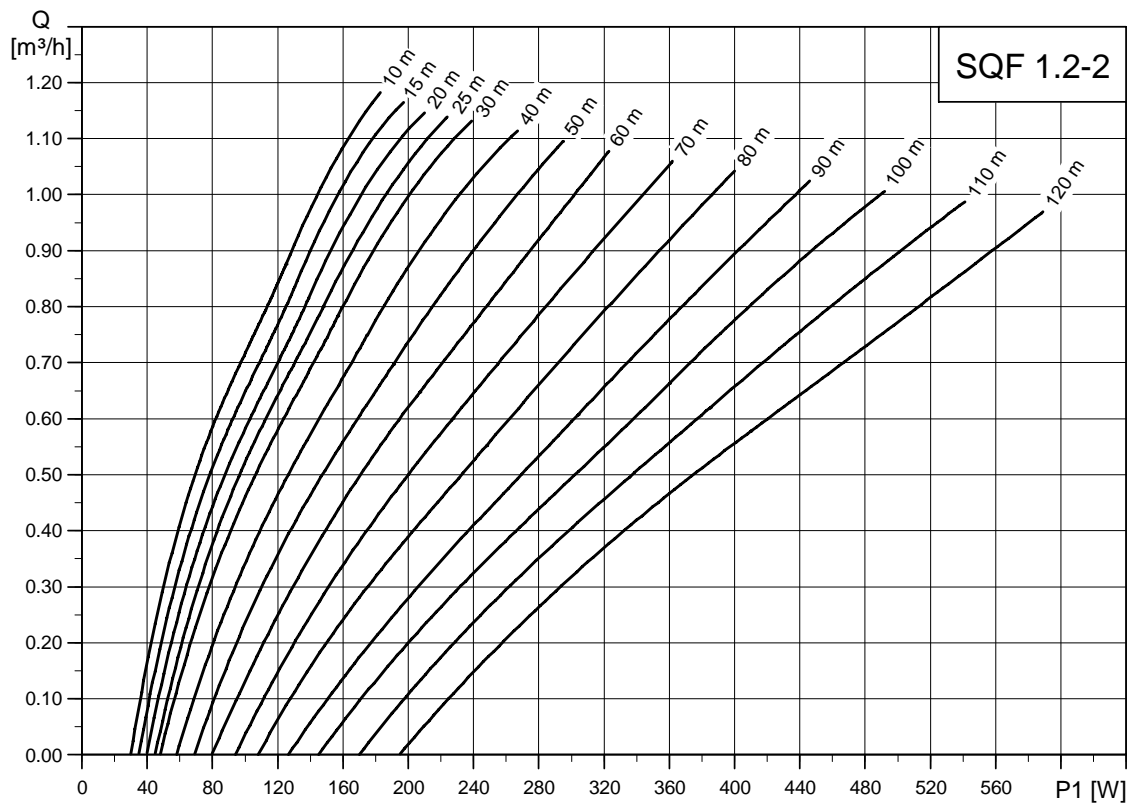

TM02 2339 1206

SQF 2.5-2

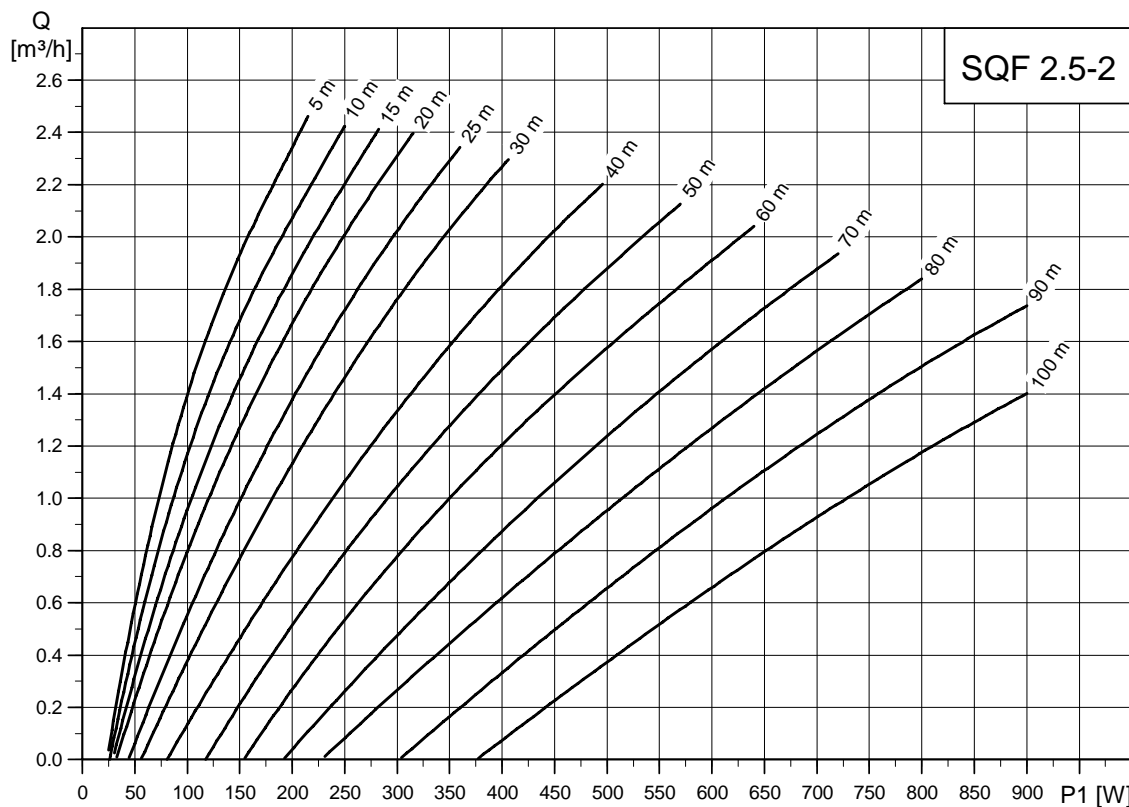

TM02 2340 1206

SQF 3A-10

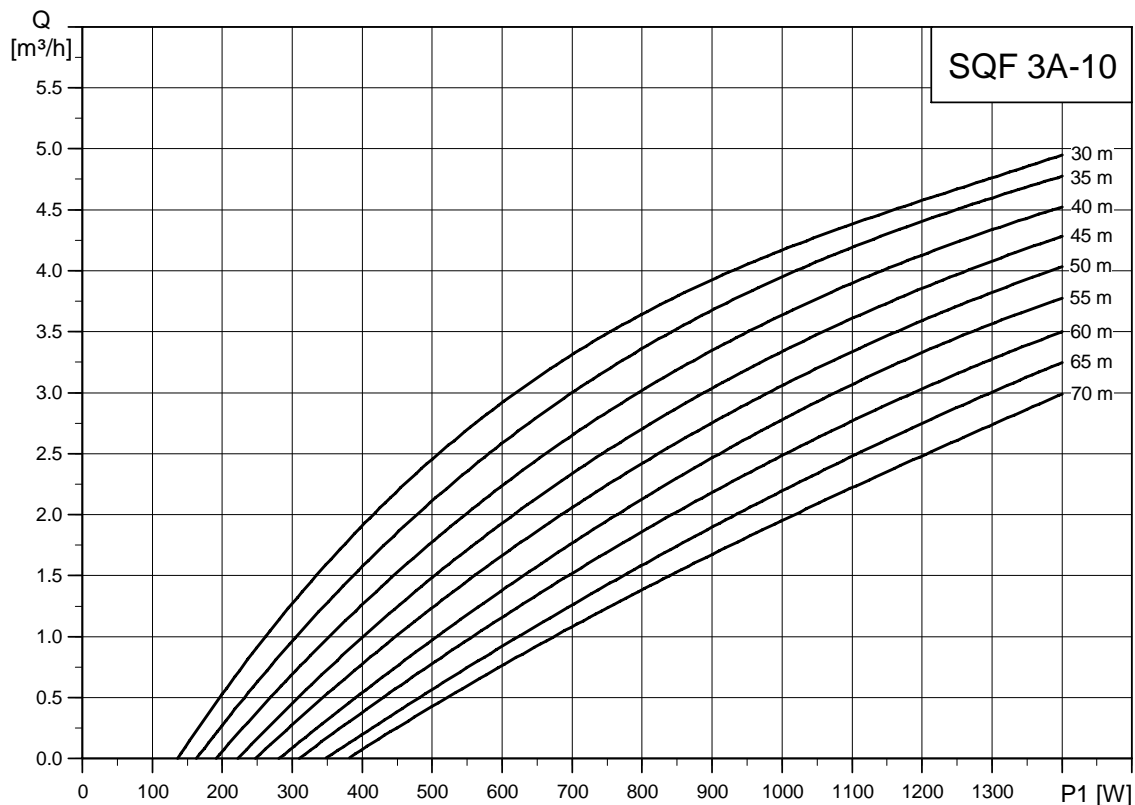

TM03 3927 1206

SQF 5A-3

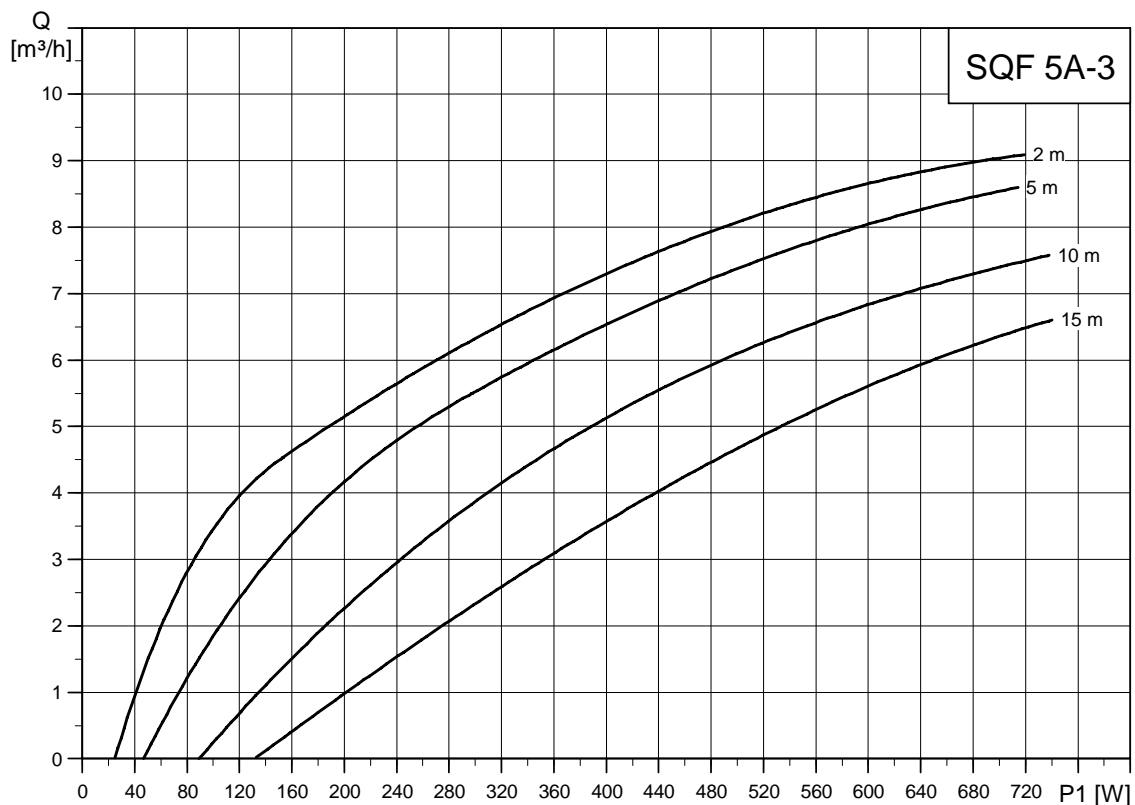

TM02 2341 4101

SQF 5A-6

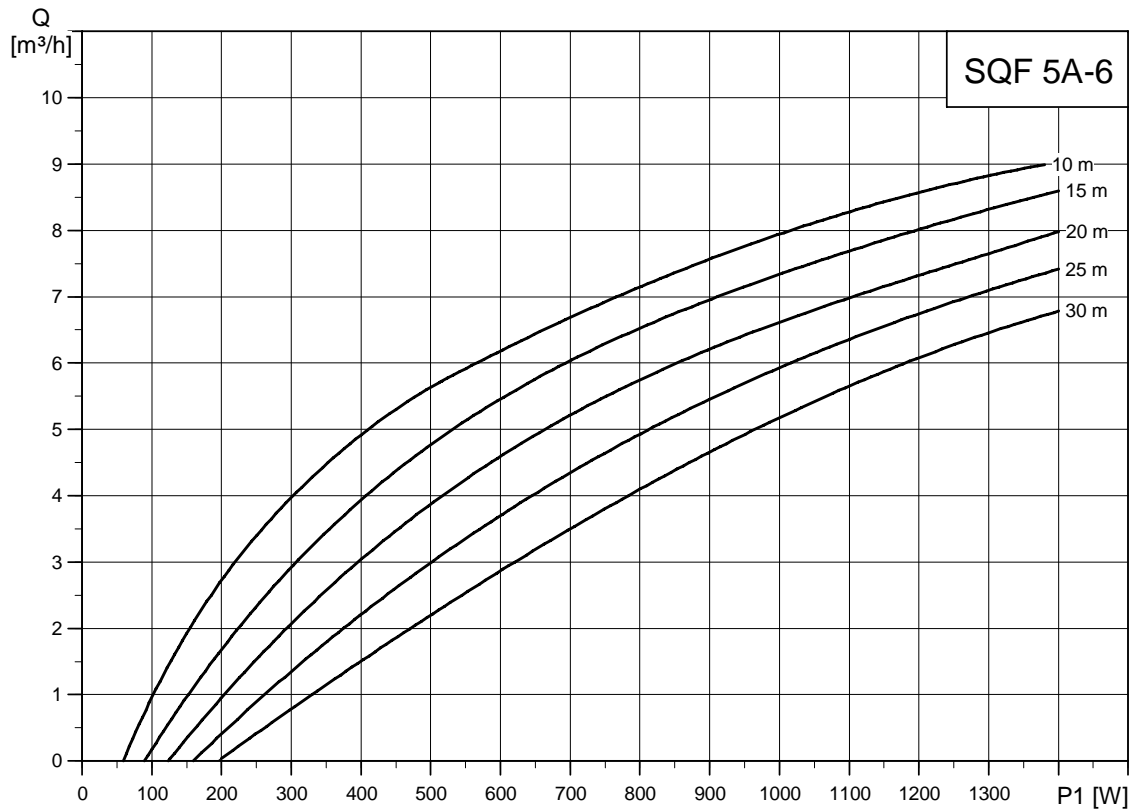

TM02 2342 1206

SQF 8A-3

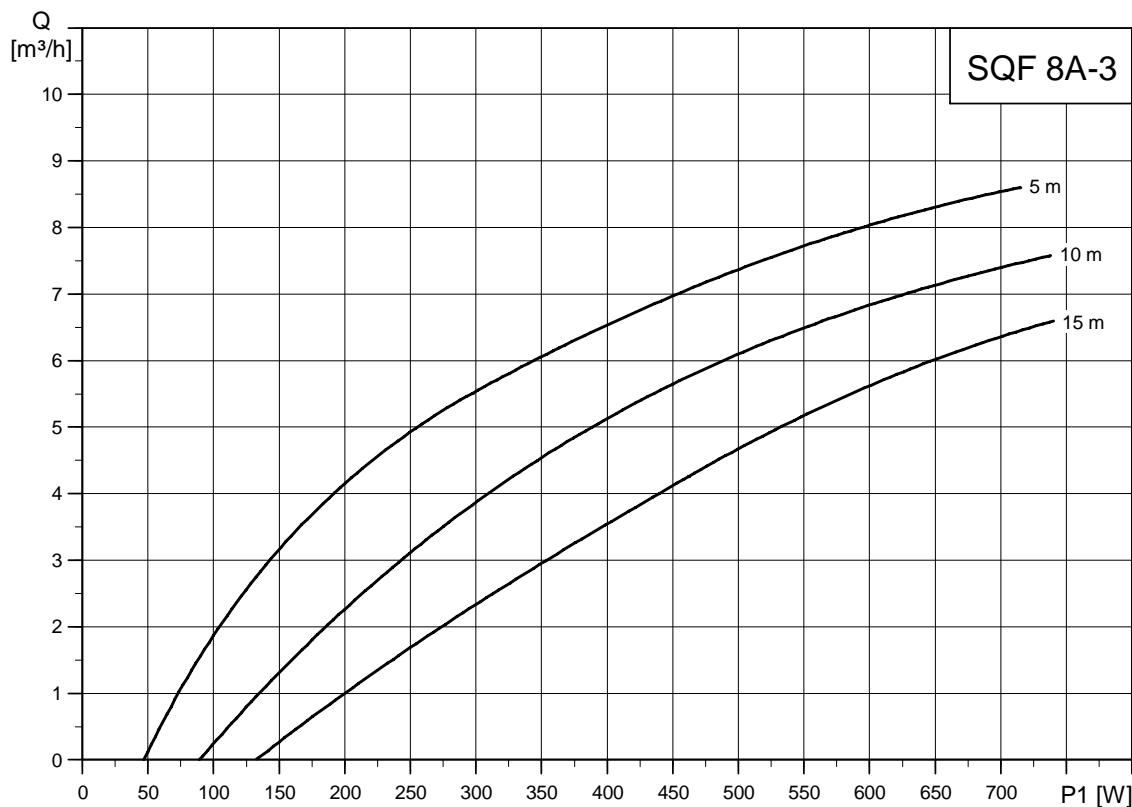

TM02 2343 1206

SQF 8A-5

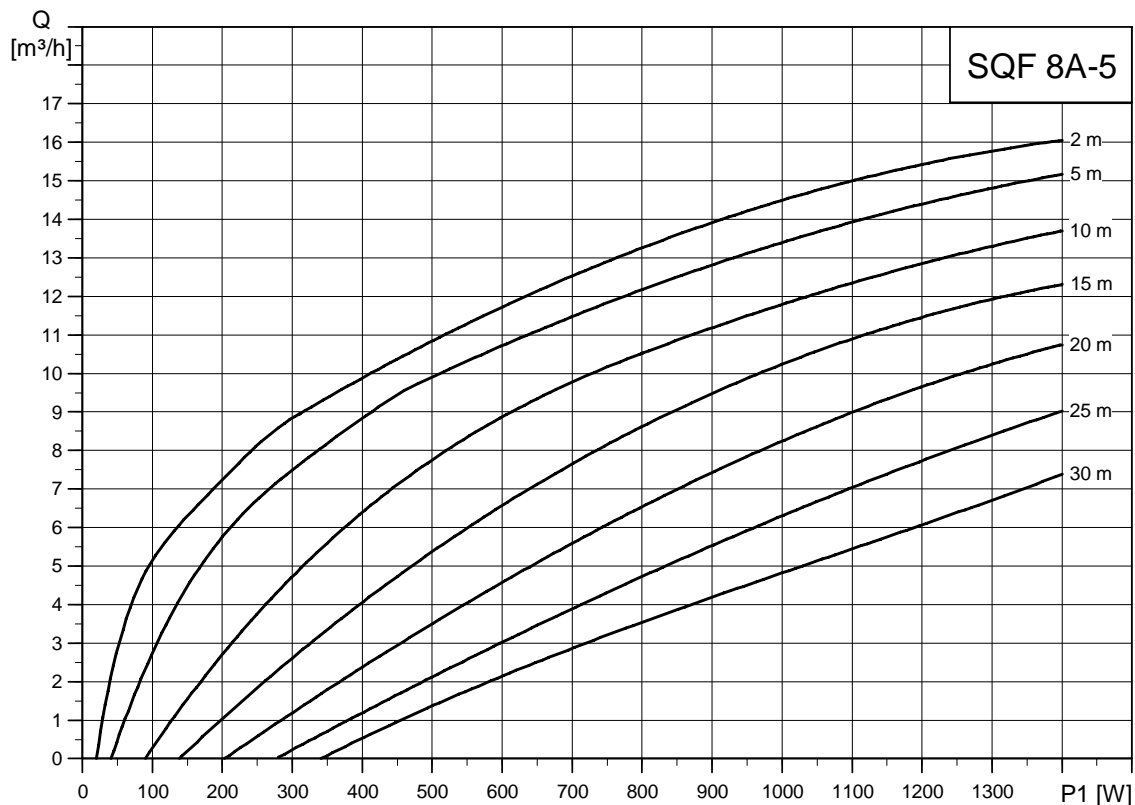

TM03 3928 1206

SQF 11A-3

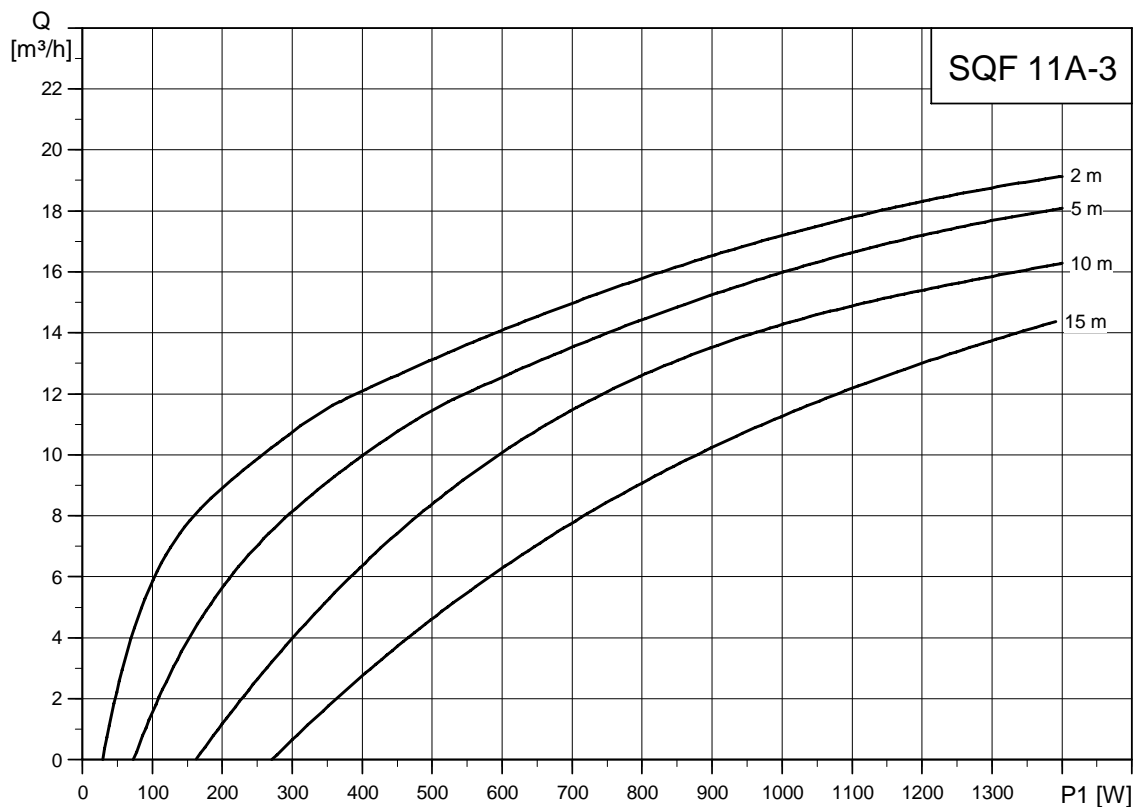

TM03 3929 1206

Dimensions and weights

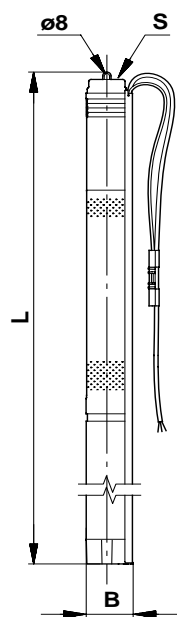

TM02 2209 3901

Pump type	Dimensions [mm]			Net weight [kg]★	Gross weight [kg]★	Shipping volume [m ³]★
	L	B	S			
SQF 0.6-2	1185 *	74	Rp 1¼	7.6	9.4	0.0242
SQF 0.6-2 N	1185 *	74	Rp 1¼	7.6	9.4	0.0242
SQF 0.6-3	1235 *	74	Rp 1¼	7.9	9.7	0.0242
SQF 0.6-3 N	1235 *	74	Rp 1¼	7.9	9.7	0.0242
SQF 1.2-2	1225 *	74	Rp 1¼	7.9	9.7	0.0242
SQF 1.2-2 N	1225 *	74	Rp 1¼	7.9	9.7	0.0242
SQF 2.5-2	1247 *	74	Rp 1¼	8.2	10.0	0.0242
SQF 2.5-2 N	1247*	74	Rp 1¼	8.2	10.0	0.0242
SQF 3A-10	968	101	Rp 1¼	9.5	11.0	0.0282
SQF 3A-10 N	1012	101	Rp 1¼	11.1	12.6	0.0282
SQF 5A-3	821	101	Rp 1½	8.1	9.6	0.0282
SQF 5A-3 N	865	101	Rp 1½	9.3	10.8	0.0282
SQF 5A-6	884	101	Rp 1½	8.8	10.3	0.0282
SQF 5A-6 N	928	101	Rp 1½	10.2	11.7	0.0282
SQF 8A-3	927	101	Rp 2	9.5	11.0	0.0282
SQF 8A-3 N	927	101	Rp 2	9.5	11.0	0.0282
SQF 8A-5	1011	101	Rp 2	10.5	12.0	0.0282
SQF 8A-5 N	1011	101	Rp 2	10.5	12.0	0.0282
SQF 11A-3	982	101	Rp 2	10.9	12.4	0.0282
SQF 11A-3 N	982	101	Rp 2	10.9	12.4	0.0282

★ Pump complete

Electrical data

30-300 VDC or 1 x 90-240 VAC, 50/60 Hz

Pump type	Motor type	Max. power input P ₁ [W]	Max. current [A]
SQF 0.6-2 (N)	MSF 3 (N)	900	8.4
SQF 0.6-3 (N)	MSF 3 (N)	900	8.4
SQF 1.2-2 (N)	MSF 3 (N)	900	8.4
SQF 2.5-2 (N)	MSF 3 (N)	900	8.4
SQF 3A-10 (N)	MSF 3 (N)	1400	8.4
SQF 5A-3 (N)	MSF 3 (N)	1400	8.4
SQF 5A-6 (N)	MSF 3 (N)	1400	8.4
SQF 8A-3 (N)	MSF 3 (N)	1400	8.4
SQF 8A-5 (N)	MSF 3 (N)	1400	8.4
SQF 11A-3 (N)	MSF 3 (N)	1400	8.4

SQF pump

Power supply to pump	30-300 VDC, PE. 1 x 90-240 V -10%/+6%, 50/60 Hz, PE.
Run-up time	Depends on the energy source.
Start/stop	No limitation to the number of starts/stops per hour.
Enclosure class	IP 68.
Motor protection	Built into the pump. Protection against <ul style="list-style-type: none"> • dry running by means of a water level electrode • overvoltage and undervoltage • overload • overtemperature.
Conductivity	≥ 70 µs/cm (micro siemens).
Sound pressure level	The sound pressure level of the pump is lower than the limiting values stated in the EC Machinery Directive.
Radio noise	The SQF complies with the EMC Directive 89/336/EEC. Approved according to the standards EN 61000-6-2 and EN 61000-6-3.
Reset function	The SQF can be reset via the CU 200 or by disconnecting the power supply for 1 minute.
Power factor	PF = 1.
Operation via generator	Voltage: 230 VAC -10%/+6%. The generator output must be <ul style="list-style-type: none"> • minimum 1 kVA (helical rotor pumps) • minimum 1.5 kVA (centrifugal pumps).
Earth-leakage circuit breaker	If the pump is connected to an electric installation where an earth-leakage circuit breaker (ELCB) is used as an additional protection, this circuit breaker must trip out when earth fault currents with DC content (pulsating DC) occur.
Borehole diameter	SQF 0.6, SQF 1.2, SQF 2.5: Minimum: 76 mm. SQF 3A, SQF 5A, SQF 8A, SQF 11A: Minimum: 104 mm.
Installation depth	Minimum: The pump must be completely submerged in the pumped liquid. Maximum: 150 m below the static water table (15 bar).
Suction strainer	Holes of the suction strainer: SQF 0.6 (N), SQF 1.2 (N), SQF 2.5 (N): ø2.3 mm. SQF 3A (N), SQF 5A: ø2.5 mm. SQF 5A N, SQF 8A (N), SQF 11A (N): 4 mm x 20 mm.
Pumped liquids	pH 5 to 9. Sand content up to 50 g/m ³ .
Marking	CE.

CU 200 SQFlex control unit

Voltage	30-300 VDC, 8.4 A. 90-240 VAC, 8.4 A.
Power consumption	5 W.
Current consumption	Maximum 130 mA.
Pump cable	Maximum length between the CU 200 and the pump: 200 m. Maximum length between the CU 200 and the level switch: 500 m.
Back-up fuse	Maximum 10 A.
Radio noise	The CU 200 complies with the EMC Directive 89/336/EEC. Approved according to the standards EN 55014 and 55014-2.
Relative air humidity	95%.
Enclosure class	IP 55.
Ambient temperature	During operation: -30°C to +50°C. During storage: -30°C to +60°C.
Marking	CE.
Weight	2 kg.

IO 100 SQFlex switch box

Voltage	Maximum 300 VDC, 8.4 A. Maximum 265 VAC, 8.4 A.
Enclosure class	IP 55.
Ambient temperature	During operation: -30°C to +50°C. During storage: -30°C to +60°C.
Marking	CE.

IO 101 SQFlex switch box

Voltage	230 VAC $-15\%/+10\%$, 50/60 Hz (internal relay). Maximum 225 VDC, 8.4 A. Maximum 265 VAC, 8.4 A.
Enclosure class	IP 55.
Ambient temperature	During operation: -30°C to $+50^{\circ}\text{C}$. During storage: -30°C to $+60^{\circ}\text{C}$.
Marking	CE.

IO 102 SQFlex breaker box

Voltage	Maximum 225 VDC, 8.4 A. Maximum 265 VAC, 8.4 A.
Enclosure class	IP 55.
Ambient temperature	During operation: -30°C to $+50^{\circ}\text{C}$. During storage: -30°C to $+60^{\circ}\text{C}$.
Marking	CE.

Charge controller

Voltage (solar input)	Maximum 110 VDC.
Current (solar input)	Maximum 15 A.
Output current (load)	Maximum 15 A.
Ambient temperature	-40°C to $+60^{\circ}\text{C}$.
Weight	0.34 kg.

Material specification, helical rotor pump

Pos.	Component	Material	SQF		SQF-N	
			EN/DIN	AISI	EN/DIN	AISI
1	Valve casing	Polyamide				
1a	Discharge chamber	Stainless steel	1.4301	304	1.4401	316
1d	O-ring	NBR				
2	Valve cup	Polyamide				
3	Valve seat	NBR				
6	Flange, upper	Stainless steel	1.4301	304	1.4401	316
7a	Circlip	Stainless spring steel	1.4310	310	1.4310	310
9	Pump stator	Stainless steel/EPDM	1.4301	304	1.4401	316
13	Pump rotor	Stainless steel	1.4301	304	1.4401	316
16	Torsion shaft	Stainless steel	1.4401	316	1.4401	316
39	Valve spring	Stainless spring steel	1.4406	316 LN	1.4406	316 LN
55	Outer sleeve	Stainless steel	1.4301	304	1.4401	316
70	Valve guide	Polyamide				
	Cable guard	Stainless steel	1.4301	304	1.4401	316
	Screws for cable guard	Stainless steel	1.4401	316	1.4401	316

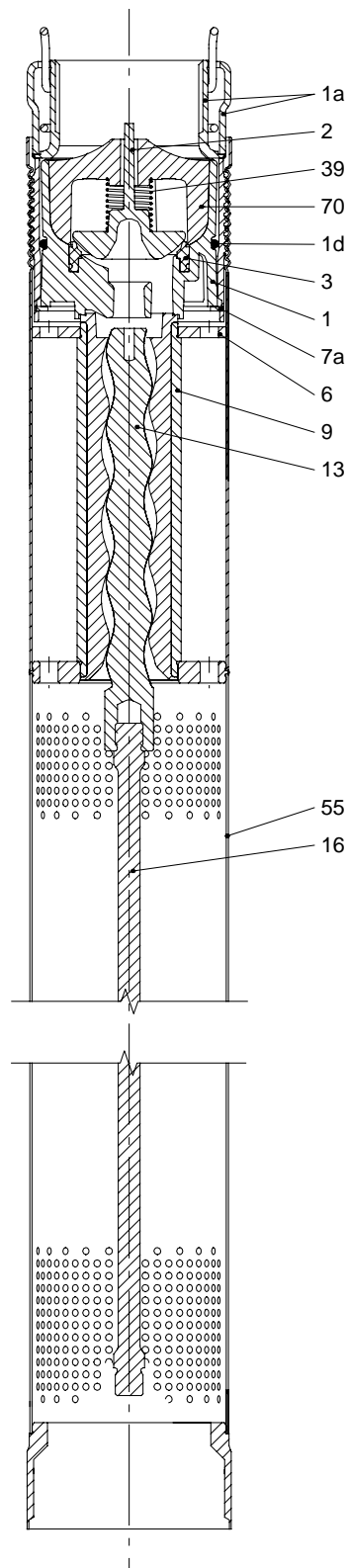

Fig. 26 Example: SQF 1.2-2

TM02 2213 3901

Material specification, centrifugal pump

Pos.	Component	Material	SQF		SQF-N	
			EN/DIN	AISI	EN/DIN	AISI
1	Valve casing	Stainless steel	1.4301	304	1.4401	316
4	Chamber, top	Stainless steel	1.4301	304	1.4401	316
6	Top bearing	NBR				
7	Neck ring	NBR/PPS				
8	Bearing	NBR				
9	Chamber, complete	Stainless steel	1.4301	304	1.4401	316
11	Nut for split cone	Stainless steel	1.4301	304	1.4401	316
12	Split cone	Stainless steel	1.4301	304	1.4401	316
13	Impeller	Stainless steel	1.4301	304	1.4401	316
14	Inlet part	Stainless steel	1.4301	304	1.4401	316
14a	Connecting piece, complete (MSF 3 adapter)	Stainless steel	1.4301	304	1.4401	316
15	Strainer	Stainless steel	1.4301	304	1.4401	316
16	Shaft, cylindrical	Stainless steel	1.4057	431	1.4460	329
17	Strap	Stainless steel	1.4301	304	1.4401	316
18	Cable guard, pump	Stainless steel	1.4301	304	1.4401	316
18c	Cable guard, motor	Stainless steel	1.4301	304	1.4401	316
19	Nut for strap	Stainless steel	1.4301	304	1.4401	316
19a	Nut	Stainless steel	1.4401	316	1.4401	316
24	Coupling with nut	Stainless steel	1.4462	329	1.4462	329
24a	Supporting ring	Stainless steel	1.4401	316	1.4401	316
24b	Spline protector	NBR				
25	Retainer for neck ring, complete	Stainless steel	1.4301	304	1.4401	316
85	Stop ring (only SQF 5A and SQF 11A)	Carbon/graphite PTFE				
	Screws for cable guard	Stainless steel	1.4401	316	1.4401	316

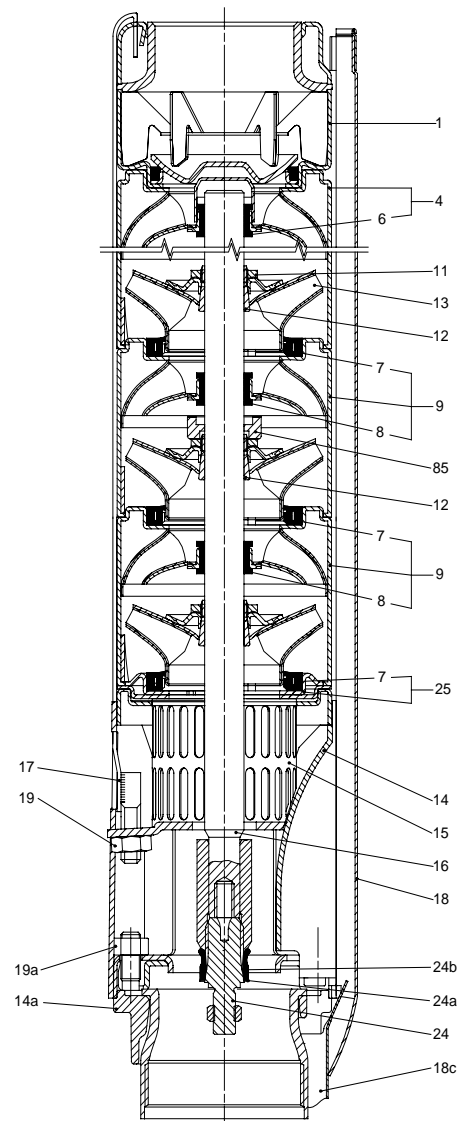

Fig. 27 Example: SQF 11A-3

TMD2 2439 4301

Material specification, motor

Pos.	Component	Material	MSF 3		MSF 3 N	
			EN/DIN	AISI	EN/DIN	AISI
201	Stator with sleeve, complete	Stainless steel	1.4301	304	1.4401	316
202	Rotor	Stainless steel	1.4301	304	1.4401	316
202a	Stop ring	PP				
202c	Shaft end	Stainless steel	1.4401	316	1.4401	316
203	Thrust bearing, stationary	Stainless steel/carbon	1.4401	316	1.4401	316
205	Bearing plate with radial bearing	Silicon carbide	1.4301	304	1.4401	316
206	Thrust bearing, rotating	Stainless steel/ aluminium oxide Al ₂ O ₃	1.4401	316	1.4401	316
220	Motor cable with plug					
222a	Filling plug	NBR				
223	Electronic unit					
224	O-ring	MSF 3: NBR. MSF 3 N: FKM.				
225	Top cover	NBR				
232	Shaft seal	MSF 3: NBR. MSF 3 N: FKM.				
243	Thrust-bearing housing	Stainless steel	1.4408	316	1.4408	316
	Four screws (M4)	Stainless steel	1.4401	316	1.4401	316

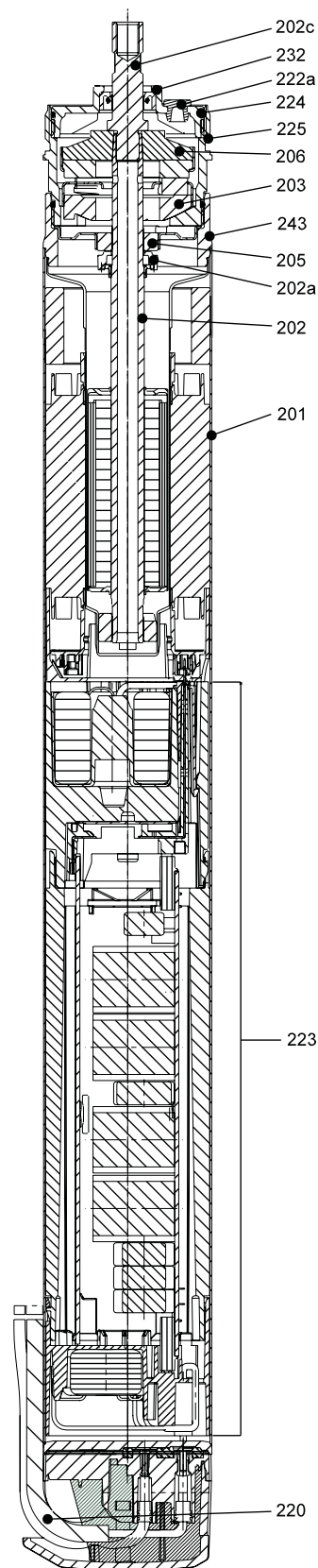
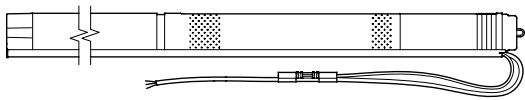

Fig. 28 MSF 3

TM02 2215 1406

SQF submersible pump



TM02 2217 3901

Fig. 29 SQF pump

The SQF pump complete is supplied with 2 m cable.

Pump type	Pump size	Product number	
		SQF	SQF-N
SQF 0.6-2 (N)	3"	95027324	95027325
SQF 0.6-3 (N)	3"	95027326	95027327
SQF 1.2-2 (N)	3"	95027328	95027329
SQF 2.5-2 (N)	3"	95027330	95027331
SQF 3A-10 (N)	3"	95027336	95027337
SQF 5A-3 (N)	4"	95027338	95027339
SQF 5A-6 (N)	4"	95027340	95027341
SQF 8A-3 (N)	4"	95027344	95027345
SQF 8A-5 (N)	4"	95027346	95027347
SQF 11A-3 (N)	4"	95027441	95027442

CU 200 SQFlex control unit

Product	Product number
CU 200 SQFlex	96625360

IO 100 SQFlex switch box

Product	Product number
IO 100 SQFlex	96475073

IO 101 SQFlex switch box

Product	Product number
IO 101 SQFlex (230 V)	96475074
IO 101 SQFlex (115 V)	96481502

IO 102 SQFlex breaker box

Product	Product number
IO 102 SQFlex for wind turbine	96475065

Water Packages

Six complete Water Packages are available. The contents of the packages appear from the table:

Water Package	Contents					Product number
	Pump type	Solar module	Switch box	Support structure	Array-to-control wire kit	
Water Package	SQF 0.6-2	To be ordered separately	IO 100 SQFlex	Pole mount	0.3 m	95027452
101 Water Package	SQF 0.6-2 N					95027453

Charge controller

Product	Product number
Charge controller	96023194

Wind turbine

Product	Product number
Whisper 200 wind turbine	

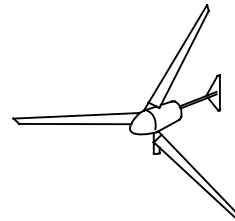

TM02 2568 4501

96472120

Submersible drop cables

The submersible drop cables for SQF pumps are approved for use with potable water (KTW-approved). The cables are made of EPR (ethylene-propylene rubber).

Sizing of cable

Use the following formula:

$$L = \frac{\Delta P \times q \times V_{mp}^2}{W_p \times 100 \times 2 \times \rho} [m]$$

where

L = Length of cable [m]

ΔP = Power loss [%]

q = Cross section of submersible drop cable [mm²]

V_{mp} = Maximum power voltage [V]

W_p = Watt peak [Wp]

ρ = Specific resistance: 0.0173 [Ω mm²/m].

The sizing tool in Grundfos WinCAPS makes it possible to calculate the exact losses.

Whisper 200 wind turbine



TM02 7886 4403

Description	Product number
Whisper 200 wind turbine	96472120

Specifications

Rotor diameter:	2.8 metres.
Weight:	30 kg.
Mount:	2.5" Schedule 40.
Start-up wind speed:	3.1 m/sec.

Tower kit for Whisper 200

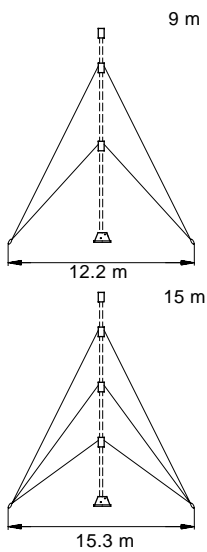

TM02 5582 3502

Description	Height [m]	Product number
Tower kit for Whisper 200	9	96475066
	15	96475067

Note: The pipes are not included.

For tower pipe selection, see below.

Tower installation kit

Description	Product number
Tower installation kit	96475069

Note: The gin pole is not included.

For tower pipe selection, see below.

Tower pipe selection

The tower kit is designed to use a 2½" (73 mm) outside diameter pipe.

The following table shows the recommended wall thickness of the pipes, depending on the maximum speed of the wind at the location:

Maximum wind speed [m/s]	Recommended wall thickness [mm]
35	2.3
40	3.0
50	3.6

The wall thickness of the gin pole must be minimum 1.6 mm.

Pipe pieces needed

Tower kit, 9 m

- One 4.0 metre length of pipe for tower.
- One 5.2 metre length of pipe for tower.
- One 4.6 metre length of pipe for gin pole.

Tower kit, 15 m

- Two 4.6 metre lengths of pipe for tower.
- One 6.1 metre length of pipe for tower.
- One 5.8 metre length of pipe for gin pole.

Auger/anchor

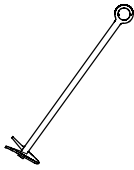

TM02 2571 4501

Description	Length [m]	Product number
Auger/anchor (4 pcs.)	1.2	96475068

Grease

Description	Product number
Grease for lubrication of motor shaft	96037562

Level switch



TM02 2407 4201

Description	Product number
Level switch	010748

High water level: Contact is closed.
Low water level: Contact is open.

Pressure switch

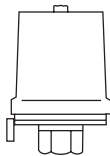

TM02 2406 1806

Description	Product number
Pressure switch	ID8952

Anemometer



GR 7667

Description	Product number
<p>The anemometer enables the measurement of</p> <ul style="list-style-type: none"> • the current wind speed (in m/sec., knots, mph or Beaufort) • the average wind speed (in m/sec., knots, mph or Beaufort) • the current temperature in degrees Celsius [°C] or Fahrenheit [°F] • the chill factor. <p>The anemometer is</p> <ul style="list-style-type: none"> • waterproof down to 10 metres • programmable. <p>Dimensions: 10 x 4 x 1 cm. Weight: 42 g.</p>	96496685

Submersible drop cable



TM00 7882 2296

Description	Version	Diameter [mm]	Product number
3-core cable, incl. earth conductor. KTW-approved. When ordering, please state length [m].	3G 1.5 mm ² (round)	9.6 - 12.5	ID7946
	3G 2.5 mm ² (round)	11.5 - 14.5	ID7947
	3G 4.0 mm ² (round)	13.0 - 16.0	ID7948
	3G 6.0 mm ² (round)	14.5 - 20.0	RM4098
	3G x 1.5 mm ² (flat)	6.5 - 13.2	RM3952

Cable termination kit, type KM

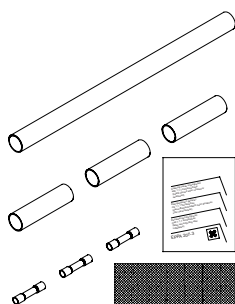

TM00 3838 1294

Description	Cross section of leads [mm ²]	Product number
For watertight shrink-joining of motor cable and submersible drop cable (round or flat cable).		
Enables the joining of <ul style="list-style-type: none"> cables of equal size cables of different size cable with single leads. 	1.5 - 2.5 4.0 - 6.0	96021462 96021473
The joint is ready for use after a few minutes and requires no long hardening time as do resin joints.		
The joint cannot be separated.		

Cable clips



TM00 4179 1994

Description	Dimensions [m]	Product number
For fastening of cable and straining wire to the riser pipe. The clips should be fitted every 3 metres. One set for approx. 45 m riser pipe.	Length = 7.5 16 buttons	115016

Straining wire



TM00 7897 2296

Description	Diameter [mm]	Product number
Stainless steel DIN W.-Nr. 1.4401. Retains the submersible pump. When ordering, please state length [m].	2	ID8957

Wire clamp



TM00 7898 2296

Description	Material	Product number
Two clamps per loop	Stainless steel DIN W.-Nr. 1.4401	ID8960

WebCAPS

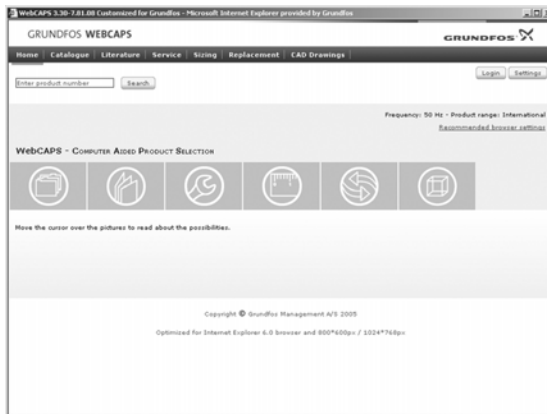

WebCAPS is a **Web-based Computer Aided Product Selection** program available on www.grundfos.com.

WebCAPS contains detailed information on more than 185,000 Grundfos products in more than 22 languages.

In WebCAPS, all information is divided into 6 sections:

- Catalogue
- Literature
- Service
- Sizing
- Replacement
- CAD drawings.

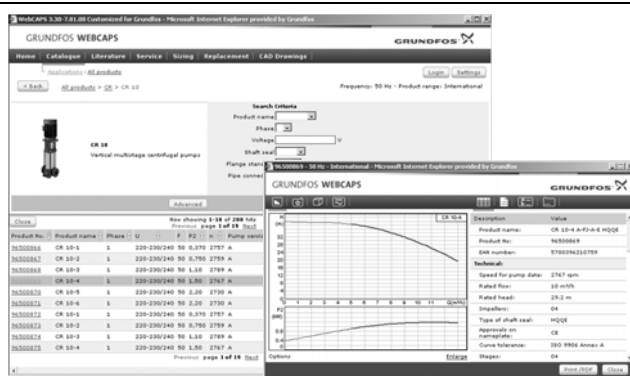

Catalogue

This section is based on fields of application and pump types, and contains

- technical data
- curves (QH, Eta, P1, P2, etc.) which can be adapted to the density and viscosity of the pumped liquid and show the number of pumps in operation
- product photos
- dimensional drawings
- wiring diagrams
- quotation texts, etc.

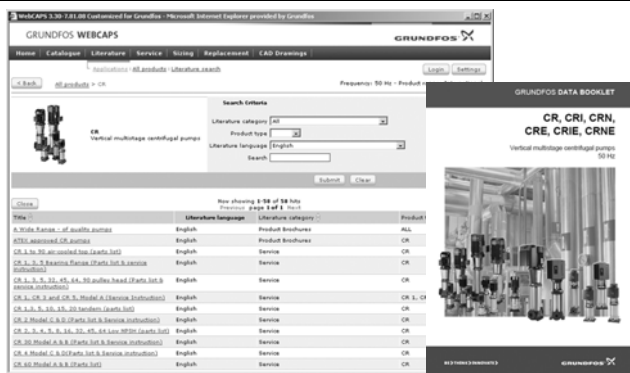

Literature

In this section you can access all the latest documents of a given pump, such as

- data booklets
- installation and operating instructions
- service documentation, such as Service kit catalogue and Service kit instructions
- quick guides
- product brochures, etc.

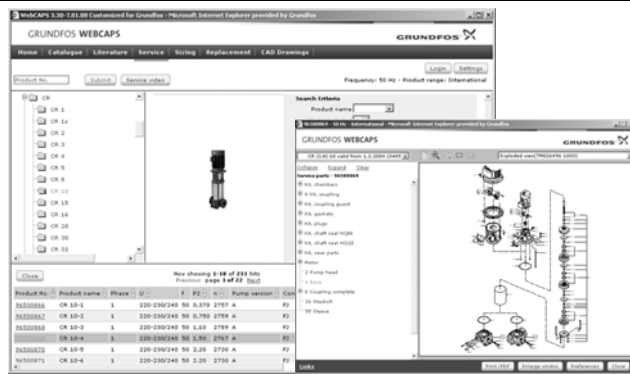

Service

This section contains an easy-to-use interactive service catalogue. Here you can find and identify service parts of both existing and discontinued Grundfos pumps. Furthermore, this section contains service videos showing you how to replace service parts.



Sizing

This section is based on different fields of application and installation examples, and gives easy step-by-step instructions in how to

- select the most suitable and efficient pump for your installation
- carry out advanced calculations based on energy consumption, payback periods, load profiles, life cycle costs, etc.
- analyse your selected pump via the built-in life cycle cost tool
- determine the flow velocity in wastewater applications, etc.



Replacement

In this section you find a guide to selecting and comparing replacement data of an installed pump in order to replace the pump with a more efficient Grundfos pump. The section contains replacement data of a wide range of pumps produced by other manufacturers than Grundfos.

Based on an easy step-by-step guide, you can compare Grundfos pumps with the one you have installed on your site. When you have specified the installed pump, the guide will suggest a number of Grundfos pumps which can improve both comfort and efficiency.



CAD drawings

In this section it is possible to download 2-dimensional (2D) and 3-dimensional (3D) CAD drawings of most Grundfos pumps.

These formats are available in WebCAPS:

- 2-dimensional drawings:
- .dxf, wireframe drawings
 - .dwg, wireframe drawings.
- 3-dimensional drawings:
- .dwg, wireframe drawings (without surfaces)
 - .stp, solid drawings (with surfaces)
 - .eprt, E-drawings.

WinCAPS



Fig. 30 WinCAPS CD-ROM

WinCAPS is a **Windows-based Computer Aided Product Selection** program containing detailed information on more than 185,000 Grundfos products in more than 22 languages.

The program contains the same features and functions as WebCAPS, but is an ideal solution if no Internet connection is available.

WinCAPS is available on CD-ROM and updated once a year.

96477803 0706	GB
Repl. 96477803 1103	

Subject to alterations.